

GY SERIES PSC HOLDER

HIGH-RIGIDITY, PRECISION MACHINING

SIMPLY CHANGE THE BLADE FOR EASY EXCHANGE BETWEEN DIFFERENT SIZES AND TYPES OF APPLICATION



GY GROOVING SERIES PSC HOLDER

MODULAR BLADES FROM THE GY SERIES ARE EASILY MOUNTED. PROVIDING A WIDE RANGE OF MACHINING CHOICES

COOLANT NOZZLES WITH ADJUSTABLE ANGLES

Coolant nozzles mounted on the main body can be adjusted to any desired angle (approx. $\pm 10^\circ$) to supply cutting fluid to the cutting edges efficiently and accurately.

OVER 100 TYPES OF MODULAR BLADES

External, face and recess machining blades can be used for machining a huge range of applications.



Recommended Maximum
Coolant Pressure: 1 MPa



PSC SYSTEM

The double taper and face contact uses the precision machined polygon geometry to provide high clamping rigidity. In addition it provides accuracy and easy positional repeatability when tool changing.

Installation size DCONMS
PSC40, PSC50, PSC63

CUTTING PERFORMANCE

COMPARISON OF FINISHED SURFACES WHEN CROSS-FEED MACHINING S45C CARBON STEEL

The GY series uses modular blades with a short overhang which exhibit excellent rigidity, especially during cross-feed machining.

	GY PSC						GY PSC			Conventional			
	max. ap 6 mm						max. ap 12 mm			max. ap 20 mm			
ap (mm)	1.0			1.5			1.0			1.0			
f (mm/rev.)	0.30	0.25	0.20	0.30	0.25	0.20	0.30	0.25	0.20	0.30	0.25	0.20	
Machined surface													
Finished surface evaluation	OK	OK	OK	OK	OK	OK	OK	OK	OK	OK	NG	NG	NG
Machining sound	OK	OK	OK	OK	OK	OK	OK	OK	OK	NG	NG	NG	

* NG - Displays chatter and vibration

Material	JIS S45C ϕ 150 mm
Cw (mm)	3
Vc (m/min)	180
Cutting mode	Cross-feed machining
Coolant	External cooling 1 Mpa

GY GROOVING SERIES PSC HOLDER

REPEAT POSITIONAL ACCURACY WITH A PSC HOLDER

Accuracy of $\pm 2 \mu\text{m}$ or less for all 3 axes is achieved when replacing tools.

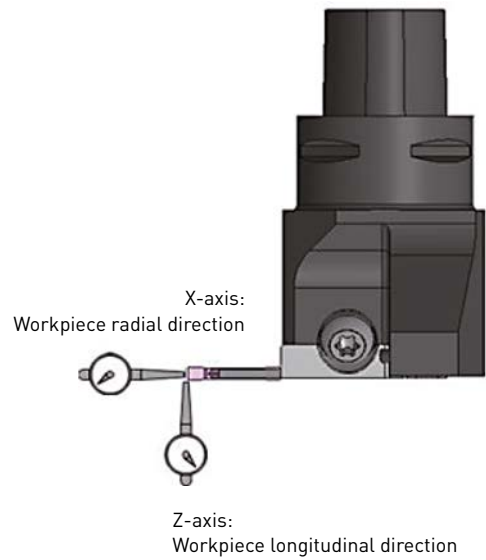
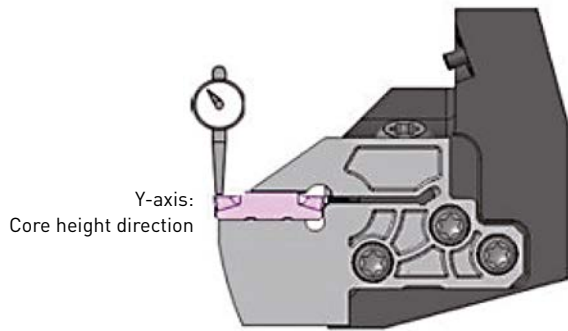

REPEAT POSITIONAL ACCURACY WITH PSC INSTALLATION

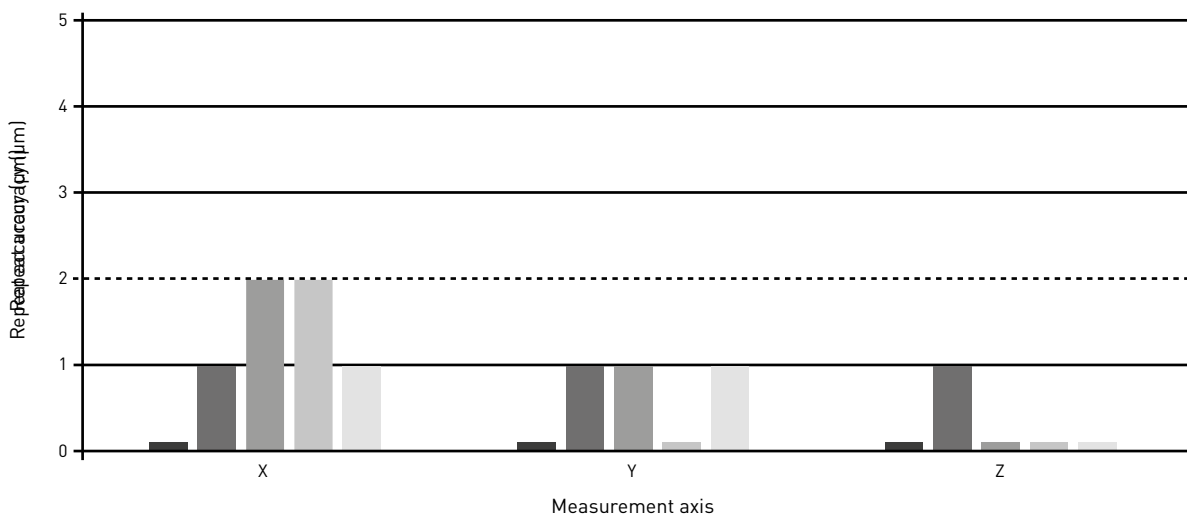

■: N1 ■: N2 ■: N3 ■: N4 ■: N5

IDENTIFICATION

PSC HOLDER ORDER NUMBER

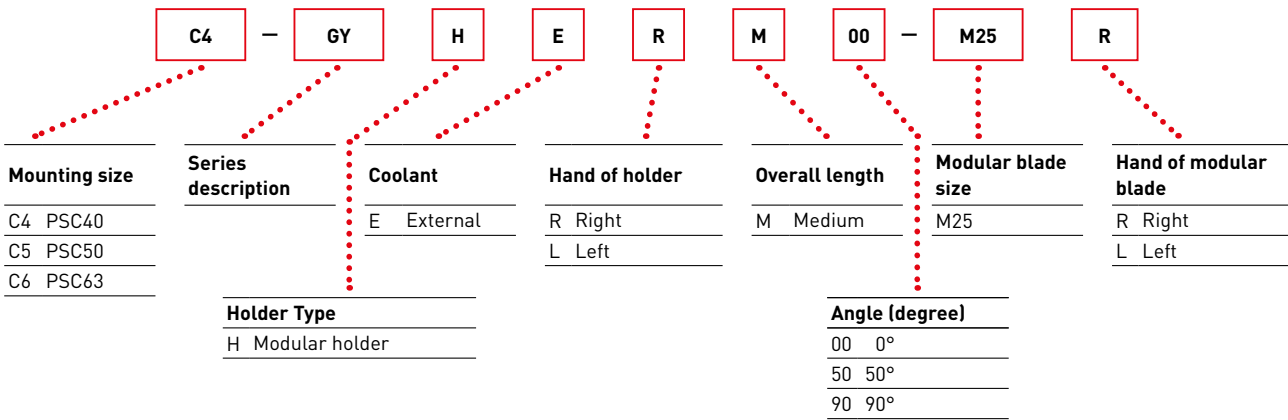

GY SERIES L DIMENSION TOLERANCE CONVERSION TABLE

The setting dimensions LF and LH shown on the next pages will change depending on the installed insert. The standard published dimensions assume GM breakers for a cutting edge angle of 00°, 90° and BM breakers for 50°.

Dimensional tolerance (mm) versus standard dimension (L) of each breaker*2									
CW	L*1	GU	GS/GM	MS/MM	R/L-GM	Flat Top	MF	BM	GL
2.00	20.70	0	0	0	0.10	0	0.35	0.20	0.35
2.24	(20.7)*3	—	—	—	—	—	0.35	—	—
2.39	20.70	0	0	—	—	0	0.35	—	—
2.50	20.70	0	0	0	0.125	0	0.35	0.20	0.35
2.74	(20.7)*3	—	—	—	—	—	0.35	—	—
3.00	20.70	0	0	0	0.15	0	0.35	0.20	0.35
3.18	20.70	0	0	—	—	0	0.35	0.20	—
3.24	(20.7)*3	—	—	—	—	—	0.35	—	—
4.00	25.65	0	0	0	0.20	0	0.30	0.15	—
4.24	(25.65)*3	—	—	—	—	—	0.30	—	—
4.75	25.65	0	0	—	—	0	0.30	0.15	—
5.00	25.65	0	0	0	0.30	0	0.30	0.15	—
5.24	(25.65)*3	—	—	—	—	—	0.30	—	—
6.00	25.65	0	0	0	—	0	0.30	0.25	—
6.31	(25.65)*3	—	—	—	—	—	0.30	—	—
6.35	25.65	0	0	—	—	—	0.30	0.25	—

*1 This value is used at the described holder dimension.

*2 - when there is no applicable breaker.

*3 The standard dimensions shown here use an approximate insert width.

GY GROOVING SERIES

EXTERNAL GROOVING

00° TYPE HOLDER

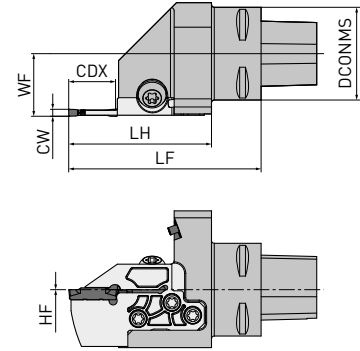

Right hand tool holder shown.

- Please order the modular blade and modular holder separately.
- Please set the right hand modular blade at the right hand holder and the left hand modular blade at the left hand holder.

Order number	Stock	Hand		Mounting size	DCONMS	CW
C4-GYHERM00-M25R	●	R	✓	PSC40	40	2.0-6.35
C4-GYHELM00-M25L	●	L	✓	PSC40	40	2.0-6.35
C5-GYHERM00-M25R	●	R	✓	PSC50	50	2.0-6.35
C5-GYHELM00-M25L	●	L	✓	PSC50	50	2.0-6.35
C6-GYHERM00-M25R	●	R	✓	PSC63	60	2.0-6.35
C6-GYHELM00-M25L	●	L	✓	PSC63	60	2.0-6.35

SET DIMENSIONS WITH MODULAR BLADES

Order number Holder	Stock	Hand	Order number Modular blade	Stock	Hand	Seat size	CW	CDX	CUTDIA	WF	HF	LF	LH
C4-GYHERM00-M25R	●	R	GYM25RA-D06	●	R			6	12	27.0	0	69	47.6
C4-GYHERM00-M25R	●	R	GYM25RA-D12	●	R	D	2.0	12	24	27.0	0	77	55.6
C4-GYHERM00-M25R	●	R	GYM25RA-D20	●	R			20	40	27.0	0	83	61.6
C4-GYHERM00-M25R	●	R	GYM25RA-E06	●	R			6	12	27.0	0	69	47.6
C4-GYHERM00-M25R	●	R	GYM25RA-E12	●	R	E	2.5	12	24	27.0	0	77	55.6
C4-GYHERM00-M25R	●	R	GYM25RA-E20	●	R			20	40	27.0	0	83	61.6
C4-GYHERM00-M25R	●	R	GYM25RA-F06	●	R			6	12	27.0	0	69	47.6
C4-GYHERM00-M25R	●	R	GYM25RA-F12	●	R	F	3.0	12	24	27.0	0	77	55.6
C4-GYHERM00-M25R	●	R	GYM25RA-F20	●	R			20	40	27.0	0	83	61.6
C4-GYHERM00-M25R	●	R	GYM25RA-G08	●	R			8	16	27.0	0	71	49.6
C4-GYHERM00-M25R	●	R	GYM25RA-G14	●	R	G	4.0	14	28	27.0	0	77	55.6
C4-GYHERM00-M25R	●	R	GYM25RA-G25	●	R			25	50	27.0	0	88	66.6
C4-GYHERM00-M25R	●	R	GYM25RA-H08	●	R			8	16	27.0	0	71	49.6
C4-GYHERM00-M25R	●	R	GYM25RA-H14	●	R	H	5.0	14	28	27.0	0	77	55.6
C4-GYHERM00-M25R	●	R	GYM25RA-H25	●	R			25	50	27.0	0	88	66.6
C4-GYHERM00-M25R	●	R	GYM25RA-J08	●	R			8	16	27.0	0	71	49.6
C4-GYHERM00-M25R	●	R	GYM25RA-J14	●	R	J	6.0	14	28	27.0	0	77	55.6
C4-GYHERM00-M25R	●	R	GYM25RA-J25	●	R			25	50	27.0	0	88	66.6

Order number Holder	Stock	Hand	Order number Modular blade	Stock	Hand	Seat size	CW	CDX	CUTDIA	WF	HF	LF	LH
C4-GYHELM00-M25L	●	L	GYM25LA-D06	●	L	D	2.0	6	12	27.0	0	69	47.6
C4-GYHELM00-M25L	●	L	GYM25LA-D12	●	L			12	24	27.0	0	77	55.6
C4-GYHELM00-M25L	●	L	GYM25LA-D20	●	L			20	40	27.0	0	83	61.6
C4-GYHELM00-M25L	●	L	GYM25LA-E06	●	L	E	2.5	6	12	27.0	0	69	47.6
C4-GYHELM00-M25L	●	L	GYM25LA-E12	●	L			12	24	27.0	0	77	55.6
C4-GYHELM00-M25L	●	L	GYM25LA-E20	●	L			20	40	27.0	0	83	61.6
C4-GYHELM00-M25L	●	L	GYM25LA-F06	●	L	F	3.0	6	12	27.0	0	69	47.6
C4-GYHELM00-M25L	●	L	GYM25LA-F12	●	L			12	24	27.0	0	77	55.6
C4-GYHELM00-M25L	●	L	GYM25LA-F20	●	L			20	40	27.0	0	83	61.6
C4-GYHELM00-M25L	●	L	GYM25LA-G08	●	L	G	4.0	8	16	27.0	0	71	49.6
C4-GYHELM00-M25L	●	L	GYM25LA-G14	●	L			14	28	27.0	0	77	55.6
C4-GYHELM00-M25L	●	L	GYM25LA-G25	●	L			25	50	27.0	0	88	66.6
C4-GYHELM00-M25L	●	L	GYM25LA-H08	●	L	H	5.0	8	16	27.0	0	71	49.6
C4-GYHELM00-M25L	●	L	GYM25LA-H14	●	L			14	28	27.0	0	77	55.6
C4-GYHELM00-M25L	●	L	GYM25LA-H25	●	L			25	50	27.0	0	88	66.6
C4-GYHELM00-M25L	●	L	GYM25LA-J08	●	L	J	6.0	8	16	27.0	0	71	49.6
C4-GYHELM00-M25L	●	L	GYM25LA-J14	●	L			14	28	27.0	0	77	55.6
C4-GYHELM00-M25L	●	L	GYM25LA-J25	●	L			25	50	27.0	0	88	66.6
C5-GYHERM00-M25R	●	R	GYM25RA-D06	●	R	D	2.0	6	12	35.0	0	69	47.6
C5-GYHERM00-M25R	●	R	GYM25RA-D12	●	R			12	24	35.0	0	77	55.6
C5-GYHERM00-M25R	●	R	GYM25RA-D20	●	R			20	40	35.0	0	83	61.6
C5-GYHERM00-M25R	●	R	GYM25RA-E06	●	R	E	2.5	6	12	35.0	0	69	47.6
C5-GYHERM00-M25R	●	R	GYM25RA-E12	●	R			12	24	35.0	0	77	55.6
C5-GYHERM00-M25R	●	R	GYM25RA-E20	●	R			20	40	35.0	0	83	61.6
C5-GYHERM00-M25R	●	R	GYM25RA-F06	●	R	F	3.0	6	12	35.0	0	69	47.6
C5-GYHERM00-M25R	●	R	GYM25RA-F12	●	R			12	24	35.0	0	77	55.6
C5-GYHERM00-M25R	●	R	GYM25RA-F20	●	R			20	40	35.0	0	83	61.6
C5-GYHERM00-M25R	●	R	GYM25RA-G08	●	R	G	4.0	8	16	35.0	0	71	49.6
C5-GYHERM00-M25R	●	R	GYM25RA-G14	●	R			14	28	35.0	0	77	55.6
C5-GYHERM00-M25R	●	R	GYM25RA-G25	●	R			25	50	35.0	0	88	66.6
C5-GYHERM00-M25R	●	R	GYM25RA-H08	●	R	H	5.0	8	16	35.0	0	71	49.6
C5-GYHERM00-M25R	●	R	GYM25RA-H14	●	R			14	28	35.0	0	77	55.6
C5-GYHERM00-M25R	●	R	GYM25RA-H25	●	R			25	50	35.0	0	88	66.6
C5-GYHERM00-M25R	●	R	GYM25RA-J08	●	R	J	6.0	8	16	35.0	0	71	49.6
C5-GYHERM00-M25R	●	R	GYM25RA-J14	●	R			14	28	35.0	0	77	55.6
C5-GYHERM00-M25R	●	R	GYM25RA-J25	●	R			25	50	35.0	0	88	66.6
C5-GYHELM00-M25L	●	L	GYM25LA-D06	●	L	D	2.0	6	12	35.0	0	69	47.6
C5-GYHELM00-M25L	●	L	GYM25LA-D12	●	L			12	24	35.0	0	77	55.6
C5-GYHELM00-M25L	●	L	GYM25LA-D20	●	L			20	40	35.0	0	83	61.6
C5-GYHELM00-M25L	●	L	GYM25LA-E06	●	L	E	2.5	6	12	35.0	0	69	47.6
C5-GYHELM00-M25L	●	L	GYM25LA-E12	●	L			12	24	35.0	0	77	55.6
C5-GYHELM00-M25L	●	L	GYM25LA-E20	●	L			20	40	35.0	0	83	61.6
C5-GYHELM00-M25L	●	L	GYM25LA-F06	●	L	F	3.0	6	12	35.0	0	69	47.6
C5-GYHELM00-M25L	●	L	GYM25LA-F12	●	L			12	24	35.0	0	77	55.6
C5-GYHELM00-M25L	●	L	GYM25LA-F20	●	L			20	40	35.0	0	83	61.6
C5-GYHELM00-M25L	●	L	GYM25LA-G08	●	L	G	4.0	8	16	35.0	0	71	49.6
C5-GYHELM00-M25L	●	L	GYM25LA-G14	●	L			14	28	35.0	0	77	55.6
C5-GYHELM00-M25L	●	L	GYM25LA-G25	●	L			25	50	35.0	0	88	66.6
C5-GYHELM00-M25L	●	L	GYM25LA-H08	●	L	H	5.0	8	16	35.0	0	71	49.6
C5-GYHELM00-M25L	●	L	GYM25LA-H14	●	L			14	28	35.0	0	77	55.6
C5-GYHELM00-M25L	●	L	GYM25LA-H25	●	L			25	50	35.0	0	88	66.6
C5-GYHELM00-M25L	●	L	GYM25LA-J08	●	L	J	6.0	8	16	35.0	0	71	49.6
C5-GYHELM00-M25L	●	L	GYM25LA-J14	●	L			14	28	35.0	0	77	55.6
C5-GYHELM00-M25L	●	L	GYM25LA-J25	●	L			25	50	35.0	0	88	66.6

● : Inventory maintained. ★ : Inventory maintained in Japan.

GY GROOVING SERIES

EXTERNAL GROOVING

00° TYPE HOLDER

Order number Holder	Stock	Hand	Order number Modular blade	Stock	Hand	Seat size	CW	CDX	CUTDIA	WF	HF	LF	LH
C6-GYHERM00-M25R	●	R	GYM25RA-D06	●	R	D	2.0	6	12	45.0	0	71	47.6
C6-GYHERM00-M25R	●	R	GYM25RA-D12	●	R			12	24	45.0	0	79	55.6
C6-GYHERM00-M25R	●	R	GYM25RA-D20	●	R			20	40	45.0	0	85	61.6
C6-GYHERM00-M25R	●	R	GYM25RA-E06	●	R	E	2.5	6	12	45.0	0	71	47.6
C6-GYHERM00-M25R	●	R	GYM25RA-E12	●	R			12	24	45.0	0	79	55.6
C6-GYHERM00-M25R	●	R	GYM25RA-E20	●	R			20	40	45.0	0	85	61.6
C6-GYHERM00-M25R	●	R	GYM25RA-F06	●	R	F	3.0	6	12	45.0	0	71	47.6
C6-GYHERM00-M25R	●	R	GYM25RA-F12	●	R			12	24	45.0	0	79	55.6
C6-GYHERM00-M25R	●	R	GYM25RA-F20	●	R			20	40	45.0	0	85	61.6
C6-GYHERM00-M25R	●	R	GYM25RA-G08	●	R	G	4.0	8	16	45.0	0	73	49.6
C6-GYHERM00-M25R	●	R	GYM25RA-G14	●	R			14	28	45.0	0	79	55.6
C6-GYHERM00-M25R	●	R	GYM25RA-G25	●	R			25	50	45.0	0	90	66.6
C6-GYHERM00-M25R	●	R	GYM25RA-H08	●	R	H	5.0	8	16	45.0	0	73	49.6
C6-GYHERM00-M25R	●	R	GYM25RA-H14	●	R			14	28	45.0	0	79	55.6
C6-GYHERM00-M25R	●	R	GYM25RA-H25	●	R			25	50	45.0	0	90	66.6
C6-GYHERM00-M25R	●	R	GYM25RA-J08	●	R	J	6.0	8	16	45.0	0	73	49.6
C6-GYHERM00-M25R	●	R	GYM25RA-J14	●	R			14	28	45.0	0	79	55.6
C6-GYHERM00-M25R	●	R	GYM25RA-J25	●	R			25	50	45.0	0	90	66.6
C6-GYHELM00-M25L	●	L	GYM25LA-D06	●	L	D	2.0	6	12	45.0	0	71	47.6
C6-GYHELM00-M25L	●	L	GYM25LA-D12	●	L			12	24	45.0	0	79	55.6
C6-GYHELM00-M25L	●	L	GYM25LA-D20	●	L			20	40	45.0	0	85	61.6
C6-GYHELM00-M25L	●	L	GYM25LA-E06	●	L	E	2.5	6	12	45.0	0	71	47.6
C6-GYHELM00-M25L	●	L	GYM25LA-E12	●	L			12	24	45.0	0	79	55.6
C6-GYHELM00-M25L	●	L	GYM25LA-E20	●	L			20	40	45.0	0	85	61.6
C6-GYHELM00-M25L	●	L	GYM25LA-F06	●	L	F	3.0	6	12	45.0	0	71	47.6
C6-GYHELM00-M25L	●	L	GYM25LA-F12	●	L			12	24	45.0	0	79	55.6
C6-GYHELM00-M25L	●	L	GYM25LA-F20	●	L			20	40	45.0	0	85	61.6
C6-GYHELM00-M25L	●	L	GYM25LA-G08	●	L	G	4.0	8	16	45.0	0	73	49.6
C6-GYHELM00-M25L	●	L	GYM25LA-G14	●	L			14	28	45.0	0	79	55.6
C6-GYHELM00-M25L	●	L	GYM25LA-G25	●	L			25	50	45.0	0	90	66.6
C6-GYHELM00-M25L	●	L	GYM25LA-H08	●	L	H	5.0	8	16	45.0	0	73	49.6
C6-GYHELM00-M25L	●	L	GYM25LA-H14	●	L			14	28	45.0	0	79	55.6
C6-GYHELM00-M25L	●	L	GYM25LA-H25	●	L			25	50	45.0	0	90	66.6
C6-GYHELM00-M25L	●	L	GYM25LA-J08	●	L	J	6.0	8	16	45.0	0	73	49.6
C6-GYHELM00-M25L	●	L	GYM25LA-J14	●	L			14	28	45.0	0	79	55.6
C6-GYHELM00-M25L	●	L	GYM25LA-J25	●	L			25	50	45.0	0	90	66.6

1. The indicated dimensions are values for standard inserts (GM breakers). If other inserts are mounted, LF and LH may differ.
Select the inserts and recommended conditions from "Brochure B140".



GY GROOVING SERIES

EXTERNAL GROOVING

90° TYPE HOLDER

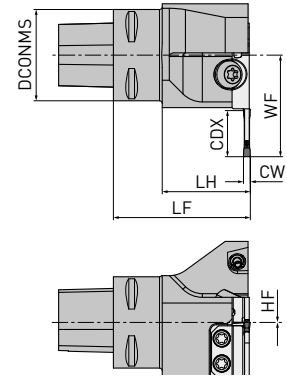

Left hand tool holder shown.

- Please order the modular blade and modular holder separately.
- Please set a left hand modular blade on a right hand holder and the right hand modular blade on a left hand holder.

Order number	Stock	Hand		Mounting size	DCONMS	CW
C4-GYHERM90-M25L	●	R	✓	PSC40	40	2.0-6.35
C4-GYHELM90-M25R	●	L	✓	PSC40	40	2.0-6.35
C5-GYHERM90-M25L	●	R	✓	PSC50	50	2.0-6.35
C5-GYHELM90-M25R	●	L	✓	PSC50	50	2.0-6.35
C6-GYHERM90-M25L	●	R	✓	PSC63	60	2.0-6.35
C6-GYHELM90-M25R	●	L	✓	PSC63	60	2.0-6.35

SET DIMENSIONS WITH MODULAR BLADES

Order number Holder	Stock	Hand	Order number Modular blade	Stock	Hand	Seat size	CW	CDX	CUTDIA	WF	HF	LF	LH
C4-GYHERM90-M25L	●	R	GYM25LA-D06	●	L	D	2.0	6	12	30.0	0	60	38.6
C4-GYHERM90-M25L	●	R	GYM25LA-D12	●	L			12	24	38.5	0	60	38.6
C4-GYHERM90-M25L	●	R	GYM25LA-D20	●	L			20	40	44.5	0	60	38.6
C4-GYHERM90-M25L	●	R	GYM25LA-E06	●	L	E	2.5	6	12	30.5	0	60	38.6
C4-GYHERM90-M25L	●	R	GYM25LA-E12	●	L			12	24	38.5	0	60	38.6
C4-GYHERM90-M25L	●	R	GYM25LA-E20	●	L			20	40	44.5	0	60	38.6
C4-GYHERM90-M25L	●	R	GYM25LA-F06	●	L	F	3.0	6	12	30.5	0	60	38.6
C4-GYHERM90-M25L	●	R	GYM25LA-F12	●	L			12	24	38.5	0	60	38.6
C4-GYHERM90-M25L	●	R	GYM25LA-F20	●	L			20	40	44.5	0	60	38.6
C4-GYHERM90-M25L	●	R	GYM25LA-G08	●	L	G	4.0	8	16	32.5	0	60	38.6
C4-GYHERM90-M25L	●	R	GYM25LA-G14	●	L			14	28	38.5	0	60	38.6
C4-GYHERM90-M25L	●	R	GYM25LA-G25	●	L			25	50	49.5	0	60	38.6
C4-GYHERM90-M25L	●	R	GYM25LA-H08	●	L	H	5.0	8	16	32.5	0	60	38.6
C4-GYHERM90-M25L	●	R	GYM25LA-H14	●	L			14	28	38.5	0	60	38.6
C4-GYHERM90-M25L	●	R	GYM25LA-H25	●	L			25	50	49.5	0	60	38.6
C4-GYHERM90-M25L	●	R	GYM25LA-J08	●	L	J	6.0	8	16	32.5	0	60	38.6
C4-GYHERM90-M25L	●	R	GYM25LA-J14	●	L			14	28	38.5	0	60	38.6
C4-GYHERM90-M25L	●	R	GYM25LA-J25	●	L			25	50	49.5	0	60	38.6

● : Inventory maintained. ★ : Inventory maintained in Japan.

GY GROOVING SERIES

EXTERNAL GROOVING

90° TYPE HOLDER

Order number Holder	Stock	Hand	Order number Modular blade	Stock	Hand	Seat size	CW	CDX	CUTDIA	WF	HF	LF	LH
C4-GYHELM90-M25R	●	L	GYM25RA-D06	●	R	D	2.0	6	12	30.0	0	60	38.6
C4-GYHELM90-M25R	●	L	GYM25RA-D12	●	R			12	24	38.5	0	60	38.6
C4-GYHELM90-M25R	●	L	GYM25RA-D20	●	R			20	40	44.5	0	60	38.6
C4-GYHELM90-M25R	●	L	GYM25RA-E06	●	R	E	2.5	6	12	30.5	0	60	38.6
C4-GYHELM90-M25R	●	L	GYM25RA-E12	●	R			12	24	38.5	0	60	38.6
C4-GYHELM90-M25R	●	L	GYM25RA-E20	●	R			20	40	44.5	0	60	38.6
C4-GYHELM90-M25R	●	L	GYM25RA-F06	●	R	F	3.0	6	12	30.5	0	60	38.6
C4-GYHELM90-M25R	●	L	GYM25RA-F12	●	R			12	24	38.5	0	60	38.6
C4-GYHELM90-M25R	●	L	GYM25RA-F20	●	R			20	40	44.5	0	60	38.6
C4-GYHELM90-M25R	●	L	GYM25RA-G08	●	R	G	4.0	8	16	32.5	0	60	38.6
C4-GYHELM90-M25R	●	L	GYM25RA-G14	●	R			14	28	38.5	0	60	38.6
C4-GYHELM90-M25R	●	L	GYM25RA-G25	●	R			25	50	49.5	0	60	38.6
C4-GYHELM90-M25R	●	L	GYM25RA-H08	●	R	H	5.0	8	16	32.5	0	60	38.6
C4-GYHELM90-M25R	●	L	GYM25RA-H14	●	R			14	28	38.5	0	60	38.6
C4-GYHELM90-M25R	●	L	GYM25RA-H25	●	R			25	50	49.5	0	60	38.6
C4-GYHELM90-M25R	●	L	GYM25RA-J08	●	R	J	6.0	8	16	32.5	0	60	38.6
C4-GYHELM90-M25R	●	L	GYM25RA-J14	●	R			14	28	38.5	0	60	38.6
C4-GYHELM90-M25R	●	L	GYM25RA-J25	●	R			25	50	49.5	0	60	38.6
C5-GYHERM90-M25L	●	R	GYM25LA-D06	●	L	D	2.0	6	12	33.0	0	60	38.6
C5-GYHERM90-M25L	●	R	GYM25LA-D12	●	L			12	24	41.0	0	60	38.6
C5-GYHERM90-M25L	●	R	GYM25LA-D20	●	L			20	40	47.0	0	60	38.6
C5-GYHERM90-M25L	●	R	GYM25LA-E06	●	L	E	2.5	6	12	33.0	0	60	38.6
C5-GYHERM90-M25L	●	R	GYM25LA-E12	●	L			12	24	41.0	0	60	38.6
C5-GYHERM90-M25L	●	R	GYM25LA-E20	●	L			20	40	47.0	0	60	38.6
C5-GYHERM90-M25L	●	R	GYM25LA-F06	●	L	F	3.0	6	12	33.0	0	60	38.6
C5-GYHERM90-M25L	●	R	GYM25LA-F12	●	L			12	24	41.0	0	60	38.6
C5-GYHERM90-M25L	●	R	GYM25LA-F20	●	L			20	40	47.0	0	60	38.6
C5-GYHERM90-M25L	●	R	GYM25LA-G08	●	L	G	4.0	8	16	35.0	0	60	38.6
C5-GYHERM90-M25L	●	R	GYM25LA-G14	●	L			14	28	41.0	0	60	38.6
C5-GYHERM90-M25L	●	R	GYM25LA-G25	●	L			25	50	52.0	0	60	38.6
C5-GYHERM90-M25L	●	R	GYM25LA-H08	●	L	H	5.0	8	16	35.0	0	60	38.6
C5-GYHERM90-M25L	●	R	GYM25LA-H14	●	L			14	28	41.0	0	60	38.6
C5-GYHERM90-M25L	●	R	GYM25LA-H25	●	L			25	50	52.0	0	60	38.6
C5-GYHERM90-M25L	●	R	GYM25LA-J08	●	L	J	6.0	8	16	35.0	0	60	38.6
C5-GYHERM90-M25L	●	R	GYM25LA-J14	●	L			14	28	41.0	0	60	38.6
C5-GYHERM90-M25L	●	R	GYM25LA-J25	●	L			25	50	52.0	0	60	38.6
C5-GYHELM90-M25R	●	L	GYM25RA-D06	●	R	D	2.0	6	12	33.0	0	60	38.6
C5-GYHELM90-M25R	●	L	GYM25RA-D12	●	R			12	24	41.0	0	60	38.6
C5-GYHELM90-M25R	●	L	GYM25RA-D20	●	R			20	40	47.0	0	60	38.6
C5-GYHELM90-M25R	●	L	GYM25RA-E06	●	R	E	2.5	6	12	33.0	0	60	38.6
C5-GYHELM90-M25R	●	L	GYM25RA-E12	●	R			12	24	41.0	0	60	38.6
C5-GYHELM90-M25R	●	L	GYM25RA-E20	●	R			20	40	47.0	0	60	38.6
C5-GYHELM90-M25R	●	L	GYM25RA-F06	●	R	F	3.0	6	12	33.0	0	60	38.6
C5-GYHELM90-M25R	●	L	GYM25RA-F12	●	R			12	24	41.0	0	60	38.6
C5-GYHELM90-M25R	●	L	GYM25RA-F20	●	R			20	40	47.0	0	60	38.6

Order number Holder	Stock	Hand	Order number Modular blade	Stock	Hand	Seat size	CW	CDX	CUTDIA	WF	HF	LF	LH	
C5-GYHELM90-M25R	●	L	GYM25RA-G08	●	R				8	16	35.0	0	60	38.6
C5-GYHELM90-M25R	●	L	GYM25RA-G14	●	R	G	4.0		14	28	41.0	0	60	38.6
C5-GYHELM90-M25R	●	L	GYM25RA-G25	●	R				25	50	52.0	0	60	38.6
C5-GYHELM90-M25R	●	L	GYM25RA-H08	●	R				8	16	35.0	0	60	38.6
C5-GYHELM90-M25R	●	L	GYM25RA-H14	●	R	H	5.0		14	28	41.0	0	60	38.6
C5-GYHELM90-M25R	●	L	GYM25RA-H25	●	R				25	50	52.0	0	60	38.6
C5-GYHELM90-M25R	●	L	GYM25RA-J08	●	R				8	16	35.0	0	60	38.6
C5-GYHELM90-M25R	●	L	GYM25RA-J14	●	R	J	6.0		14	28	41.0	0	60	38.6
C5-GYHELM90-M25R	●	L	GYM25RA-J25	●	R				25	50	52.0	0	60	38.6
C6-GYHERM90-M25L	●	R	GYM25LA-D06	●	L				6	12	40.0	0	70	46.6
C6-GYHERM90-M25L	●	R	GYM25LA-D12	●	L	D	2.0		12	24	48.0	0	70	46.6
C6-GYHERM90-M25L	●	R	GYM25LA-D20	●	L				20	40	54.0	0	70	46.6
C6-GYHERM90-M25L	●	R	GYM25LA-E06	●	L				6	12	40.0	0	70	46.6
C6-GYHERM90-M25L	●	R	GYM25LA-E12	●	L	E	2.5		12	24	48.0	0	70	46.6
C6-GYHERM90-M25L	●	R	GYM25LA-E20	●	L				20	40	54.0	0	70	46.6
C6-GYHERM90-M25L	●	R	GYM25LA-F06	●	L				6	12	40.0	0	70	46.6
C6-GYHERM90-M25L	●	R	GYM25LA-F12	●	L	F	3.0		12	24	48.0	0	70	46.6
C6-GYHERM90-M25L	●	R	GYM25LA-F20	●	L				20	40	54.0	0	70	46.6
C6-GYHERM90-M25L	●	R	GYM25LA-G08	●	L				8	16	42.0	0	70	46.6
C6-GYHERM90-M25L	●	R	GYM25LA-G14	●	L	G	4.0		14	28	48.0	0	70	46.6
C6-GYHERM90-M25L	●	R	GYM25LA-G25	●	L				25	50	59.0	0	70	46.6
C6-GYHERM90-M25L	●	R	GYM25LA-H08	●	L				8	16	42.0	0	70	46.6
C6-GYHERM90-M25L	●	R	GYM25LA-H14	●	L	H	5.0		14	28	48.0	0	70	46.6
C6-GYHERM90-M25L	●	R	GYM25LA-H25	●	L				25	50	59.0	0	70	46.6
C6-GYHERM90-M25L	●	R	GYM25LA-J08	●	L				8	16	42.0	0	70	46.6
C6-GYHERM90-M25L	●	R	GYM25LA-J14	●	L	J	6.0		14	28	48.0	0	70	46.6
C6-GYHERM90-M25L	●	R	GYM25LA-J25	●	L				25	50	59.0	0	70	46.6
C6-GYHELM90-M25R	●	L	GYM25RA-D06	●	R				6	12	40.0	0	70	46.6
C6-GYHELM90-M25R	●	L	GYM25RA-D12	●	R	D	2.0		12	24	48.0	0	70	46.6
C6-GYHELM90-M25R	●	L	GYM25RA-D20	●	R				20	40	54.0	0	70	46.6
C6-GYHELM90-M25R	●	L	GYM25RA-E06	●	R				6	12	40.0	0	70	46.6
C6-GYHELM90-M25R	●	L	GYM25RA-E12	●	R	E	2.5		12	24	48.0	0	70	46.6
C6-GYHELM90-M25R	●	L	GYM25RA-E20	●	R				20	40	54.0	0	70	46.6
C6-GYHELM90-M25R	●	L	GYM25RA-F06	●	R				6	12	40.0	0	70	46.6
C6-GYHELM90-M25R	●	L	GYM25RA-F12	●	R	F	3.0		12	24	48.0	0	70	46.6
C6-GYHELM90-M25R	●	L	GYM25RA-F20	●	R				20	40	54.0	0	70	46.6
C6-GYHELM90-M25R	●	L	GYM25RA-G08	●	R				8	16	42.0	0	70	46.6
C6-GYHELM90-M25R	●	L	GYM25RA-G14	●	R	G	4.0		14	28	48.0	0	70	46.6
C6-GYHELM90-M25R	●	L	GYM25RA-G25	●	R				25	50	59.0	0	70	46.6
C6-GYHELM90-M25R	●	L	GYM25RA-H08	●	R				8	16	42.0	0	70	46.6
C6-GYHELM90-M25R	●	L	GYM25RA-H14	●	R	H	5.0		14	28	48.0	0	70	46.6
C6-GYHELM90-M25R	●	L	GYM25RA-H25	●	R				25	50	59.0	0	70	46.6
C6-GYHELM90-M25R	●	L	GYM25RA-J08	●	R				8	16	42.0	0	70	46.6
C6-GYHELM90-M25R	●	L	GYM25RA-J14	●	R	J	6.0		14	28	48.0	0	70	46.6
C6-GYHELM90-M25R	●	L	GYM25RA-J25	●	R				25	50	59.0	0	70	46.6

1. The indicated dimensions are values for standard inserts (GM breakers). If other inserts are mounted, LF and LH may differ.
Select the inserts and recommended conditions from "Brochure B140".

GY GROOVING SERIES

FACE GROOVING

00° TYPE HOLDER

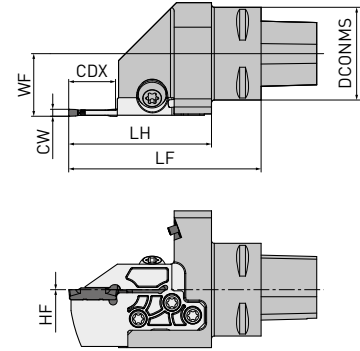

Right hand tool holder shown.

- Please order the modular blade and modular holder separately.
- Please set a right hand modular blade on a right hand holder and a left hand modular blade on a left hand holder.

Order number	Stock	Hand		Mounting size	DCONMS	CW
C4-GYHERM00-M25R	●	R	✓	PSC40	40	2.0-6.35
C4-GYHELM00-M25L	●	L	✓	PSC40	40	2.0-6.35
C5-GYHERM00-M25R	●	R	✓	PSC50	50	2.0-6.35
C5-GYHELM00-M25L	●	L	✓	PSC50	50	2.0-6.35
C6-GYHERM00-M25R	●	R	✓	PSC63	60	2.0-6.35
C6-GYHELM00-M25L	●	L	✓	PSC63	60	2.0-6.35

SET DIMENSIONS WITH MODULAR BLADES

Order number Holder	Stock	Hand	Order number Modular blade	Stock	Hand	Seat size	CW	DAXN	DAXX	CDX	WF	HF	LF	LH
C4-GYHERM00-M25R	●	R	GYM25RD-D12-040	●	R	D	2.0	40	50	12	27.0	0	77	55.6
C4-GYHERM00-M25R	●	R	GYM25RD-D12-050	●	R			50	60	12	27.0	0	77	55.6
C4-GYHERM00-M25R	●	R	GYM25RD-D12-060	●	R			60	75	12	27.0	0	77	55.6
C4-GYHERM00-M25R	●	R	GYM25RD-D12-075	●	R			75	100	12	27.0	0	77	55.6
C4-GYHERM00-M25R	●	R	GYM25RD-D12-100	●	R			100	150	12	27.0	0	77	55.6
C4-GYHERM00-M25R	●	R	GYM25RD-D12-135	●	R			135	200	12	27.0	0	77	55.6
C4-GYHERM00-M25R	●	R	GYM25RD-D12-180	●	R			180	250	12	27.0	0	77	55.6
C4-GYHERM00-M25R	●	R	GYM25RD-E12-040	●	R	E	2.5	40	50	12	27.0	0	77	55.6
C4-GYHERM00-M25R	●	R	GYM25RD-E12-050	●	R			50	60	12	27.0	0	77	55.6
C4-GYHERM00-M25R	●	R	GYM25RD-E12-060	●	R			60	75	12	27.0	0	77	55.6
C4-GYHERM00-M25R	●	R	GYM25RD-E12-075	●	R			75	100	12	27.0	0	77	55.6
C4-GYHERM00-M25R	●	R	GYM25RD-E12-100	●	R			100	150	12	27.0	0	77	55.6
C4-GYHERM00-M25R	●	R	GYM25RD-E12-135	●	R			135	200	12	27.0	0	77	55.6
C4-GYHERM00-M25R	●	R	GYM25RD-E12-180	●	R			180	250	12	27.0	0	77	55.6

Order number Holder	Stock	Hand	Order number Modular blade	Stock	Hand	Seat size	CW	DAXN	DAXX	CDX	WF	HF	LF	LH		
C4-GYHERM00-M25R	●	R	GYM25RD-F12-035	●	R	F	3.0	35	40	12	27.0	0	77	55.6		
C4-GYHERM00-M25R	●	R	GYM25RD-F12-040	●	R			40	50	12	27.0	0	77	55.6		
C4-GYHERM00-M25R	●	R	GYM25RD-F12-050	●	R			50	60	12	27.0	0	77	55.6		
C4-GYHERM00-M25R	●	R	GYM25RD-F12-060	●	R			60	75	12	27.0	0	77	55.6		
C4-GYHERM00-M25R	●	R	GYM25RD-F12-075	●	R			75	100	12	27.0	0	77	55.6		
C4-GYHERM00-M25R	●	R	GYM25RD-F12-100	●	R			100	150	12	27.0	0	77	55.6		
C4-GYHERM00-M25R	●	R	GYM25RD-F12-135	●	R			135	200	12	27.0	0	77	55.6		
C4-GYHERM00-M25R	●	R	GYM25RD-F12-180	●	R			180	250	12	27.0	0	77	55.6		
C4-GYHERM00-M25R	●	R	GYM25RD-F12-225	●	R			225	999	12	27.0	0	77	55.6		
C4-GYHERM00-M25R	●	R	GYM25RD-F20-060	●	R			60	75	20	27.0	0	83	61.6		
C4-GYHERM00-M25R	●	R	GYM25RD-F20-075	●	R			75	100	20	27.0	0	83	61.6		
C4-GYHERM00-M25R	●	R	GYM25RD-F20-100	●	R			100	150	20	27.0	0	83	61.6		
C4-GYHERM00-M25R	●	R	GYM25RD-F20-135	●	R			135	200	20	27.0	0	83	61.6		
C4-GYHERM00-M25R	●	R	GYM25RD-F20-180	●	R			180	250	20	27.0	0	83	61.6		
C4-GYHERM00-M25R	●	R	GYM25RD-F20-225	●	R			225	999	20	27.0	0	83	61.6		
C4-GYHERM00-M25R	●	R	GYM25RD-G14-040	●	R			G	4.0	40	50	14	27.0	0	77	55.6
C4-GYHERM00-M25R	●	R	GYM25RD-G14-050	●	R	50	60			14	27.0	0	77	55.6		
C4-GYHERM00-M25R	●	R	GYM25RD-G14-060	●	R	60	85			14	27.0	0	77	55.6		
C4-GYHERM00-M25R	●	R	GYM25RD-G14-085	●	R	85	125			14	27.0	0	77	55.6		
C4-GYHERM00-M25R	●	R	GYM25RD-G14-125	●	R	125	200			14	27.0	0	77	55.6		
C4-GYHERM00-M25R	●	R	GYM25RD-G14-180	●	R	180	280			14	27.0	0	77	55.6		
C4-GYHERM00-M25R	●	R	GYM25RD-G14-250	●	R	250	999			14	27.0	0	77	55.6		
C4-GYHERM00-M25R	●	R	GYM25RD-G25-060	●	R	60	85			25	27.0	0	88	66.6		
C4-GYHERM00-M25R	●	R	GYM25RD-G25-085	●	R	85	125			25	27.0	0	88	66.6		
C4-GYHERM00-M25R	●	R	GYM25RD-G25-125	●	R	125	200			25	27.0	0	88	66.6		
C4-GYHERM00-M25R	●	R	GYM25RD-G25-180	●	R	180	280			25	27.0	0	88	66.6		
C4-GYHERM00-M25R	●	R	GYM25RD-G25-250	●	R	250	999			25	27.0	0	88	66.6		
C4-GYHERM00-M25R	●	R	GYM25RD-H14-050	●	R	H	5.0			50	60	14	27.0	0	77	55.6
C4-GYHERM00-M25R	●	R	GYM25RD-H14-060	●	R					60	85	14	27.0	0	77	55.6
C4-GYHERM00-M25R	●	R	GYM25RD-H14-085	●	R					85	125	14	27.0	0	77	55.6
C4-GYHERM00-M25R	●	R	GYM25RD-H14-125	●	R					125	200	14	27.0	0	77	55.6
C4-GYHERM00-M25R	●	R	GYM25RD-H14-180	●	R			180	280	14	27.0	0	77	55.6		
C4-GYHERM00-M25R	●	R	GYM25RD-H14-250	●	R			250	999	14	27.0	0	77	55.6		
C4-GYHERM00-M25R	●	R	GYM25RD-H25-060	●	R			60	85	25	27.0	0	88	66.6		
C4-GYHERM00-M25R	●	R	GYM25RD-H25-085	●	R			85	125	25	27.0	0	88	66.6		
C4-GYHERM00-M25R	●	R	GYM25RD-H25-125	●	R			125	200	25	27.0	0	88	66.6		
C4-GYHERM00-M25R	●	R	GYM25RD-H25-180	●	R			180	280	25	27.0	0	88	66.6		
C4-GYHERM00-M25R	●	R	GYM25RD-H25-250	●	R			250	999	25	27.0	0	88	66.6		
C4-GYHERM00-M25R	●	R	GYM25RD-J14-050	●	R			J	6.0	50	70	14	27.0	0	77	55.6
C4-GYHERM00-M25R	●	R	GYM25RD-J14-070	●	R					70	110	14	27.0	0	77	55.6
C4-GYHERM00-M25R	●	R	GYM25RD-J14-110	●	R					110	200	14	27.0	0	77	55.6
C4-GYHERM00-M25R	●	R	GYM25RD-J14-170	●	R					170	280	14	27.0	0	77	55.6
C4-GYHERM00-M25R	●	R	GYM25RD-J14-250	●	R					250	999	14	27.0	0	77	55.6
C4-GYHERM00-M25R	●	R	GYM25RD-J25-070	●	R	70	110			25	27.0	0	88	66.6		
C4-GYHERM00-M25R	●	R	GYM25RD-J25-110	●	R	110	200			25	27.0	0	88	66.6		
C4-GYHERM00-M25R	●	R	GYM25RD-J25-170	●	R	170	280			25	27.0	0	88	66.6		
C4-GYHERM00-M25R	●	R	GYM25RD-J25-250	●	R	250	999			25	27.0	0	88	66.6		
C4-GYHELM00-M25L	●	L	GYM25LD-D12-040	●	L	D	2.0			40	50	12	27.0	0	77	55.6
C4-GYHELM00-M25L	●	L	GYM25LD-D12-050	●	L					50	60	12	27.0	0	77	55.6
C4-GYHELM00-M25L	●	L	GYM25LD-D12-060	●	L					60	75	12	27.0	0	77	55.6
C4-GYHELM00-M25L	●	L	GYM25LD-D12-075	●	L					75	100	12	27.0	0	77	55.6
C4-GYHELM00-M25L	●	L	GYM25LD-D12-100	●	L					100	150	12	27.0	0	77	55.6
C4-GYHELM00-M25L	●	L	GYM25LD-D12-135	●	L					135	200	12	27.0	0	77	55.6
C4-GYHELM00-M25L	●	L	GYM25LD-D12-180	●	L					180	250	12	27.0	0	77	55.6

● : Inventory maintained. ★ : Inventory maintained in Japan.



GY GROOVING SERIES

FACE GROOVING

00° TYPE HOLDER

Order number Holder	Stock	Hand	Order number Modular blade	Stock	Hand	Seat size	CW	DAXN	DAXX	CDX	WF	HF	LF	LH
C4-GYHELM00-M25L	●	L	GYM25LD-E12-040	●	L	E	2.5	40	50	12	27.0	0	77	55.6
C4-GYHELM00-M25L	●	L	GYM25LD-E12-050	●	L			50	60	12	27.0	0	77	55.6
C4-GYHELM00-M25L	●	L	GYM25LD-E12-060	●	L			60	75	12	27.0	0	77	55.6
C4-GYHELM00-M25L	●	L	GYM25LD-E12-075	●	L			75	100	12	27.0	0	77	55.6
C4-GYHELM00-M25L	●	L	GYM25LD-E12-100	●	L			100	150	12	27.0	0	77	55.6
C4-GYHELM00-M25L	●	L	GYM25LD-E12-135	●	L			135	200	12	27.0	0	77	55.6
C4-GYHELM00-M25L	●	L	GYM25LD-E12-180	●	L			180	250	12	27.0	0	77	55.6
C4-GYHELM00-M25L	●	L	GYM25LD-F12-035	●	L			35	40	12	27.0	0	77	55.6
C4-GYHELM00-M25L	●	L	GYM25LD-F12-040	●	L			40	50	12	27.0	0	77	55.6
C4-GYHELM00-M25L	●	L	GYM25LD-F12-050	●	L			50	60	12	27.0	0	77	55.6
C4-GYHELM00-M25L	●	L	GYM25LD-F12-060	●	L			60	75	12	27.0	0	77	55.6
C4-GYHELM00-M25L	●	L	GYM25LD-F12-075	●	L			75	100	12	27.0	0	77	55.6
C4-GYHELM00-M25L	●	L	GYM25LD-F12-100	●	L			100	150	12	27.0	0	77	55.6
C4-GYHELM00-M25L	●	L	GYM25LD-F12-135	●	L			135	200	12	27.0	0	77	55.6
C4-GYHELM00-M25L	●	L	GYM25LD-F12-180	●	L	180	250	12	27.0	0	77	55.6		
C4-GYHELM00-M25L	●	L	GYM25LD-F20-225	●	L	225	999	12	27.0	0	77	55.6		
C4-GYHELM00-M25L	●	L	GYM25LD-F20-060	●	L	60	75	20	27.0	0	83	61.6		
C4-GYHELM00-M25L	●	L	GYM25LD-F20-075	●	L	75	100	20	27.0	0	83	61.6		
C4-GYHELM00-M25L	●	L	GYM25LD-F20-100	●	L	100	150	20	27.0	0	83	61.6		
C4-GYHELM00-M25L	●	L	GYM25LD-F20-135	●	L	135	200	20	27.0	0	83	61.6		
C4-GYHELM00-M25L	●	L	GYM25LD-F20-180	●	L	180	250	20	27.0	0	83	61.6		
C4-GYHELM00-M25L	●	L	GYM25LD-F20-225	●	L	225	999	20	27.0	0	83	61.6		
C4-GYHELM00-M25L	●	L	GYM25LD-G14-040	●	L	40	50	14	27.0	0	77	55.6		
C4-GYHELM00-M25L	●	L	GYM25LD-G14-050	●	L	50	60	14	27.0	0	77	55.6		
C4-GYHELM00-M25L	●	L	GYM25LD-G14-060	●	L	60	85	14	27.0	0	77	55.6		
C4-GYHELM00-M25L	●	L	GYM25LD-G14-085	●	L	85	125	14	27.0	0	77	55.6		
C4-GYHELM00-M25L	●	L	GYM25LD-G14-125	●	L	125	200	14	27.0	0	77	55.6		
C4-GYHELM00-M25L	●	L	GYM25LD-G14-180	●	L	180	280	14	27.0	0	77	55.6		
C4-GYHELM00-M25L	●	L	GYM25LD-G14-250	●	L	250	999	14	27.0	0	77	55.6		
C4-GYHELM00-M25L	●	L	GYM25LD-G25-060	●	L	60	85	25	27.0	0	88	66.6		
C4-GYHELM00-M25L	●	L	GYM25LD-G25-085	●	L	85	125	25	27.0	0	88	66.6		
C4-GYHELM00-M25L	●	L	GYM25LD-G25-125	●	L	125	200	25	27.0	0	88	66.6		
C4-GYHELM00-M25L	●	L	GYM25LD-G25-180	●	L	180	280	25	27.0	0	88	66.6		
C4-GYHELM00-M25L	●	L	GYM25LD-G25-250	●	L	250	999	25	27.0	0	88	66.6		
C4-GYHELM00-M25L	●	L	GYM25LD-H14-050	●	L	50	60	14	27.0	0	77	55.6		
C4-GYHELM00-M25L	●	L	GYM25LD-H14-060	●	L	60	85	14	27.0	0	77	55.6		
C4-GYHELM00-M25L	●	L	GYM25LD-H14-085	●	L	85	125	14	27.0	0	77	55.6		
C4-GYHELM00-M25L	●	L	GYM25LD-H14-125	●	L	125	200	14	27.0	0	77	55.6		
C4-GYHELM00-M25L	●	L	GYM25LD-H14-180	●	L	180	280	14	27.0	0	77	55.6		
C4-GYHELM00-M25L	●	L	GYM25LD-H14-250	●	L	250	999	14	27.0	0	77	55.6		
C4-GYHELM00-M25L	●	L	GYM25LD-H25-060	●	L	60	85	25	27.0	0	88	66.6		
C4-GYHELM00-M25L	●	L	GYM25LD-H25-085	●	L	85	125	25	27.0	0	88	66.6		
C4-GYHELM00-M25L	●	L	GYM25LD-H25-125	●	L	125	200	25	27.0	0	88	66.6		
C4-GYHELM00-M25L	●	L	GYM25LD-H25-180	●	L	180	280	25	27.0	0	88	66.6		
C4-GYHELM00-M25L	●	L	GYM25LD-H25-250	●	L	250	999	25	27.0	0	88	66.6		

Order number Holder	Stock	Hand	Order number Modular blade	Stock	Hand	Seat size	CW	DAXN	DAXX	CDX	WF	HF	LF	LH
C4-GYHELM00-M25L	●	L	GYM25LD-J14-050	●	L	J	6.0	50	70	14	27.0	0	77	55.6
C4-GYHELM00-M25L	●	L	GYM25LD-J14-070	●	L			70	110	14	27.0	0	77	55.6
C4-GYHELM00-M25L	●	L	GYM25LD-J14-110	●	L			110	200	14	27.0	0	77	55.6
C4-GYHELM00-M25L	●	L	GYM25LD-J14-170	●	L			170	280	14	27.0	0	77	55.6
C4-GYHELM00-M25L	●	L	GYM25LD-J14-250	●	L			250	999	14	27.0	0	77	55.6
C4-GYHELM00-M25L	●	L	GYM25LD-J25-070	●	L			70	110	25	27.0	0	88	66.6
C4-GYHELM00-M25L	●	L	GYM25LD-J25-110	●	L			110	200	25	27.0	0	88	66.6
C4-GYHELM00-M25L	●	L	GYM25LD-J25-170	●	L			170	280	25	27.0	0	88	66.6
C4-GYHELM00-M25L	●	L	GYM25LD-J25-250	●	L			250	999	25	27.0	0	88	66.6
C5-GYHERM00-M25R	●	R	GYM25RD-D12-040	●	R			D	2.0	40	50	12	27.0	0
C5-GYHERM00-M25R	●	R	GYM25RD-D12-050	●	R	50	60			12	27.0	0	77	55.6
C5-GYHERM00-M25R	●	R	GYM25RD-D12-060	●	R	60	75			12	27.0	0	77	55.6
C5-GYHERM00-M25R	●	R	GYM25RD-D12-075	●	R	75	100			12	27.0	0	77	55.6
C5-GYHERM00-M25R	●	R	GYM25RD-D12-100	●	R	100	150			12	27.0	0	77	55.6
C5-GYHERM00-M25R	●	R	GYM25RD-D12-135	●	R	135	200			12	27.0	0	77	55.6
C5-GYHERM00-M25R	●	R	GYM25RD-D12-180	●	R	180	250			12	27.0	0	77	55.6
C5-GYHERM00-M25R	●	R	GYM25RD-E12-040	●	R	40	50			12	27.0	0	77	55.6
C5-GYHERM00-M25R	●	R	GYM25RD-E12-050	●	R	50	60			12	27.0	0	77	55.6
C5-GYHERM00-M25R	●	R	GYM25RD-E12-060	●	R	60	75			12	27.0	0	77	55.6
C5-GYHERM00-M25R	●	R	GYM25RD-E12-075	●	R	E	2.5	75	100	12	27.0	0	77	55.6
C5-GYHERM00-M25R	●	R	GYM25RD-E12-100	●	R			100	150	12	27.0	0	77	55.6
C5-GYHERM00-M25R	●	R	GYM25RD-E12-135	●	R			135	200	12	27.0	0	77	55.6
C5-GYHERM00-M25R	●	R	GYM25RD-E12-180	●	R			180	250	12	27.0	0	77	55.6
C5-GYHERM00-M25R	●	R	GYM25RD-F12-035	●	R			35	40	12	27.0	0	77	55.6
C5-GYHERM00-M25R	●	R	GYM25RD-F12-040	●	R			40	50	12	27.0	0	77	55.6
C5-GYHERM00-M25R	●	R	GYM25RD-F12-050	●	R			50	60	12	27.0	0	77	55.6
C5-GYHERM00-M25R	●	R	GYM25RD-F12-060	●	R			60	75	12	27.0	0	77	55.6
C5-GYHERM00-M25R	●	R	GYM25RD-F12-075	●	R			75	100	12	27.0	0	77	55.6
C5-GYHERM00-M25R	●	R	GYM25RD-F12-100	●	R			100	150	12	27.0	0	77	55.6
C5-GYHERM00-M25R	●	R	GYM25RD-F12-135	●	R	135	200	12	27.0	0	77	55.6		
C5-GYHERM00-M25R	●	R	GYM25RD-F12-180	●	R	F	3.0	180	250	12	27.0	0	77	55.6
C5-GYHERM00-M25R	●	R	GYM25RD-F12-225	●	R			225	999	12	27.0	0	77	55.6
C5-GYHERM00-M25R	●	R	GYM25RD-F20-060	●	R			60	75	20	27.0	0	83	61.6
C5-GYHERM00-M25R	●	R	GYM25RD-F20-075	●	R			75	100	20	27.0	0	83	61.6
C5-GYHERM00-M25R	●	R	GYM25RD-F20-100	●	R			100	150	20	27.0	0	83	61.6
C5-GYHERM00-M25R	●	R	GYM25RD-F20-135	●	R			135	200	20	27.0	0	83	61.6
C5-GYHERM00-M25R	●	R	GYM25RD-F20-180	●	R			180	250	20	27.0	0	83	61.6
C5-GYHERM00-M25R	●	R	GYM25RD-F20-225	●	R			225	999	20	27.0	0	83	61.6
C5-GYHERM00-M25R	●	R	GYM25RD-G14-040	●	R			40	50	14	27.0	0	77	55.6
C5-GYHERM00-M25R	●	R	GYM25RD-G14-050	●	R			50	60	14	27.0	0	77	55.6
C5-GYHERM00-M25R	●	R	GYM25RD-G14-060	●	R	60	85	14	27.0	0	77	55.6		
C5-GYHERM00-M25R	●	R	GYM25RD-G14-085	●	R	85	125	14	27.0	0	77	55.6		
C5-GYHERM00-M25R	●	R	GYM25RD-G14-125	●	R	125	200	14	27.0	0	77	55.6		
C5-GYHERM00-M25R	●	R	GYM25RD-G14-180	●	R	G	4.0	180	280	14	27.0	0	77	55.6
C5-GYHERM00-M25R	●	R	GYM25RD-G14-250	●	R			250	999	14	27.0	0	77	55.6
C5-GYHERM00-M25R	●	R	GYM25RD-G25-060	●	R			60	85	25	27.0	0	88	66.6
C5-GYHERM00-M25R	●	R	GYM25RD-G25-085	●	R			85	125	25	27.0	0	88	66.6
C5-GYHERM00-M25R	●	R	GYM25RD-G25-125	●	R			125	200	25	27.0	0	88	66.6
C5-GYHERM00-M25R	●	R	GYM25RD-G25-180	●	R			180	280	25	27.0	0	88	66.6
C5-GYHERM00-M25R	●	R	GYM25RD-G25-250	●	R			250	999	25	27.0	0	88	66.6

GY GROOVING SERIES

FACE GROOVING

00° TYPE HOLDER

Order number Holder	Stock	Hand	Order number Modular blade	Stock	Hand	Seat size	CW	DAXN	DAXX	CDX	WF	HF	LF	LH		
C5-GYHERM00-M25R	●	R	GYM25RD-H14-050	●	R	H	5.0	50	60	14	27.0	0	77	55.6		
C5-GYHERM00-M25R	●	R	GYM25RD-H14-060	●	R			60	85	14	27.0	0	77	55.6		
C5-GYHERM00-M25R	●	R	GYM25RD-H14-085	●	R			85	125	14	27.0	0	77	55.6		
C5-GYHERM00-M25R	●	R	GYM25RD-H14-125	●	R			125	200	14	27.0	0	77	55.6		
C5-GYHERM00-M25R	●	R	GYM25RD-H14-180	●	R			180	280	14	27.0	0	77	55.6		
C5-GYHERM00-M25R	●	R	GYM25RD-H14-250	●	R			250	999	14	27.0	0	77	55.6		
C5-GYHERM00-M25R	●	R	GYM25RD-H25-060	●	R			60	85	25	27.0	0	88	66.6		
C5-GYHERM00-M25R	●	R	GYM25RD-H25-085	●	R			85	125	25	27.0	0	88	66.6		
C5-GYHERM00-M25R	●	R	GYM25RD-H25-125	●	R			125	200	25	27.0	0	88	66.6		
C5-GYHERM00-M25R	●	R	GYM25RD-H25-180	●	R			180	280	25	27.0	0	88	66.6		
C5-GYHERM00-M25R	●	R	GYM25RD-H25-250	●	R			250	999	25	27.0	0	88	66.6		
C5-GYHERM00-M25R	●	R	GYM25RD-J14-050	●	R			J	6.0	50	70	14	27.0	0	77	55.6
C5-GYHERM00-M25R	●	R	GYM25RD-J14-070	●	R	70	110			14	27.0	0	77	55.6		
C5-GYHERM00-M25R	●	R	GYM25RD-J14-110	●	R	110	200			14	27.0	0	77	55.6		
C5-GYHERM00-M25R	●	R	GYM25RD-J14-170	●	R	170	280			14	27.0	0	77	55.6		
C5-GYHERM00-M25R	●	R	GYM25RD-J14-250	●	R	250	999			14	27.0	0	77	55.6		
C5-GYHERM00-M25R	●	R	GYM25RD-J25-070	●	R	70	110			25	27.0	0	88	66.6		
C5-GYHERM00-M25R	●	R	GYM25RD-J25-110	●	R	110	200			25	27.0	0	88	66.6		
C5-GYHERM00-M25R	●	R	GYM25RD-J25-170	●	R	170	280			25	27.0	0	88	66.6		
C5-GYHERM00-M25R	●	R	GYM25RD-J25-250	●	R	250	999			25	27.0	0	88	66.6		
C5-GYHELM00-M25L	●	L	GYM25LD-D12-040	●	L	D	2.0			40	50	12	27.0	0	77	55.6
C5-GYHELM00-M25L	●	L	GYM25LD-D12-050	●	L					50	60	12	27.0	0	77	55.6
C5-GYHELM00-M25L	●	L	GYM25LD-D12-060	●	L					60	75	12	27.0	0	77	55.6
C5-GYHELM00-M25L	●	L	GYM25LD-D12-075	●	L			75	100	12	27.0	0	77	55.6		
C5-GYHELM00-M25L	●	L	GYM25LD-D12-100	●	L			100	150	12	27.0	0	77	55.6		
C5-GYHELM00-M25L	●	L	GYM25LD-D12-135	●	L			135	200	12	27.0	0	77	55.6		
C5-GYHELM00-M25L	●	L	GYM25LD-D12-180	●	L			180	250	12	27.0	0	77	55.6		
C5-GYHELM00-M25L	●	L	GYM25LD-E12-040	●	L			40	50	12	27.0	0	77	55.6		
C5-GYHELM00-M25L	●	L	GYM25LD-E12-050	●	L			50	60	12	27.0	0	77	55.6		
C5-GYHELM00-M25L	●	L	GYM25LD-E12-060	●	L			60	75	12	27.0	0	77	55.6		
C5-GYHELM00-M25L	●	L	GYM25LD-E12-075	●	L			75	100	12	27.0	0	77	55.6		
C5-GYHELM00-M25L	●	L	GYM25LD-E12-100	●	L			100	150	12	27.0	0	77	55.6		
C5-GYHELM00-M25L	●	L	GYM25LD-E12-135	●	L	135	200	12	27.0	0	77	55.6				
C5-GYHELM00-M25L	●	L	GYM25LD-E12-180	●	L	180	250	12	27.0	0	77	55.6				

Order number Holder	Stock	Hand	Order number Modular blade	Stock	Hand	Seat size	CW	DAXN	DAXX	CDX	WF	HF	LF	LH		
C5-GYHELM00-M25L	●	L	GYM25LD-F12-035	●	L	F	3.0	35	40	12	27.0	0	77	55.6		
C5-GYHELM00-M25L	●	L	GYM25LD-F12-040	●	L			40	50	12	27.0	0	77	55.6		
C5-GYHELM00-M25L	●	L	GYM25LD-F12-050	●	L			50	60	12	27.0	0	77	55.6		
C5-GYHELM00-M25L	●	L	GYM25LD-F12-060	●	L			60	75	12	27.0	0	77	55.6		
C5-GYHELM00-M25L	●	L	GYM25LD-F12-075	●	L			75	100	12	27.0	0	77	55.6		
C5-GYHELM00-M25L	●	L	GYM25LD-F12-100	●	L			100	150	12	27.0	0	77	55.6		
C5-GYHELM00-M25L	●	L	GYM25LD-F12-135	●	L			135	200	12	27.0	0	77	55.6		
C5-GYHELM00-M25L	●	L	GYM25LD-F12-180	●	L			180	250	12	27.0	0	77	55.6		
C5-GYHELM00-M25L	●	L	GYM25LD-F12-225	●	L			225	999	12	27.0	0	77	55.6		
C5-GYHELM00-M25L	●	L	GYM25LD-F20-060	●	L			60	75	20	27.0	0	83	61.6		
C5-GYHELM00-M25L	●	L	GYM25LD-F20-075	●	L			75	100	20	27.0	0	83	61.6		
C5-GYHELM00-M25L	●	L	GYM25LD-F20-100	●	L			100	150	20	27.0	0	83	61.6		
C5-GYHELM00-M25L	●	L	GYM25LD-F20-135	●	L			135	200	20	27.0	0	83	61.6		
C5-GYHELM00-M25L	●	L	GYM25LD-F20-180	●	L			180	250	20	27.0	0	83	61.6		
C5-GYHELM00-M25L	●	L	GYM25LD-F20-225	●	L			225	999	20	27.0	0	83	61.6		
C5-GYHELM00-M25L	●	L	GYM25LD-G14-040	●	L			G	4.0	40	50	14	27.0	0	77	55.6
C5-GYHELM00-M25L	●	L	GYM25LD-G14-050	●	L					50	60	14	27.0	0	77	55.6
C5-GYHELM00-M25L	●	L	GYM25LD-G14-060	●	L					60	85	14	27.0	0	77	55.6
C5-GYHELM00-M25L	●	L	GYM25LD-G14-085	●	L					85	125	14	27.0	0	77	55.6
C5-GYHELM00-M25L	●	L	GYM25LD-G14-125	●	L					125	200	14	27.0	0	77	55.6
C5-GYHELM00-M25L	●	L	GYM25LD-G14-180	●	L	180	280			14	27.0	0	77	55.6		
C5-GYHELM00-M25L	●	L	GYM25LD-G14-250	●	L	250	999			14	27.0	0	77	55.6		
C5-GYHELM00-M25L	●	L	GYM25LD-G25-060	●	L	60	85			25	27.0	0	88	66.6		
C5-GYHELM00-M25L	●	L	GYM25LD-G25-085	●	L	85	125			25	27.0	0	88	66.6		
C5-GYHELM00-M25L	●	L	GYM25LD-G25-125	●	L	125	200			25	27.0	0	88	66.6		
C5-GYHELM00-M25L	●	L	GYM25LD-G25-180	●	L	180	280			25	27.0	0	88	66.6		
C5-GYHELM00-M25L	●	L	GYM25LD-G25-250	●	L	250	999			25	27.0	0	88	66.6		
C5-GYHELM00-M25L	●	L	GYM25LD-H14-050	●	L	H	5.0			50	60	14	27.0	0	77	55.6
C5-GYHELM00-M25L	●	L	GYM25LD-H14-060	●	L					60	85	14	27.0	0	77	55.6
C5-GYHELM00-M25L	●	L	GYM25LD-H14-085	●	L					85	125	14	27.0	0	77	55.6
C5-GYHELM00-M25L	●	L	GYM25LD-H14-125	●	L					125	200	14	27.0	0	77	55.6
C5-GYHELM00-M25L	●	L	GYM25LD-H14-180	●	L					180	280	14	27.0	0	77	55.6
C5-GYHELM00-M25L	●	L	GYM25LD-H14-250	●	L					250	999	14	27.0	0	77	55.6
C5-GYHELM00-M25L	●	L	GYM25LD-H25-060	●	L					60	85	25	27.0	0	88	66.6
C5-GYHELM00-M25L	●	L	GYM25LD-H25-085	●	L					85	125	25	27.0	0	88	66.6
C5-GYHELM00-M25L	●	L	GYM25LD-H25-125	●	L			125	200	25	27.0	0	88	66.6		
C5-GYHELM00-M25L	●	L	GYM25LD-H25-180	●	L			180	280	25	27.0	0	88	66.6		
C5-GYHELM00-M25L	●	L	GYM25LD-H25-250	●	L			250	999	25	27.0	0	88	66.6		
C5-GYHELM00-M25L	●	L	GYM25LD-J14-050	●	L			J	6.0	50	70	14	27.0	0	77	55.6
C5-GYHELM00-M25L	●	L	GYM25LD-J14-070	●	L					70	110	14	27.0	0	77	55.6
C5-GYHELM00-M25L	●	L	GYM25LD-J14-110	●	L					110	200	14	27.0	0	77	55.6
C5-GYHELM00-M25L	●	L	GYM25LD-J14-170	●	L					170	280	14	27.0	0	77	55.6
C5-GYHELM00-M25L	●	L	GYM25LD-J14-250	●	L					250	999	14	27.0	0	77	55.6
C5-GYHELM00-M25L	●	L	GYM25LD-J25-070	●	L					70	110	25	27.0	0	88	66.6
C5-GYHELM00-M25L	●	L	GYM25LD-J25-110	●	L					110	200	25	27.0	0	88	66.6
C5-GYHELM00-M25L	●	L	GYM25LD-J25-170	●	L					170	280	25	27.0	0	88	66.6
C5-GYHELM00-M25L	●	L	GYM25LD-J25-250	●	L					250	999	25	27.0	0	88	66.6
C6-GYHERM00-M25R	●	R	GYM25RD-D12-040	●	R	D	2.0			40	50	12	27.0	0	79	55.6
C6-GYHERM00-M25R	●	R	GYM25RD-D12-050	●	R			50	60	12	27.0	0	79	55.6		
C6-GYHERM00-M25R	●	R	GYM25RD-D12-060	●	R			60	75	12	27.0	0	79	55.6		
C6-GYHERM00-M25R	●	R	GYM25RD-D12-075	●	R			75	100	12	27.0	0	79	55.6		
C6-GYHERM00-M25R	●	R	GYM25RD-D12-100	●	R			100	150	12	27.0	0	79	55.6		
C6-GYHERM00-M25R	●	R	GYM25RD-D12-135	●	R			135	200	12	27.0	0	79	55.6		
C6-GYHERM00-M25R	●	R	GYM25RD-D12-180	●	R			180	250	12	27.0	0	79	55.6		

● : Inventory maintained. ★ : Inventory maintained in Japan.



GY GROOVING SERIES

FACE GROOVING

00° TYPE HOLDER

Order number Holder	Stock	Hand	Order number Modular blade	Stock	Hand	Seat size	CW	DAXN	DAXX	CDX	WF	HF	LF	LH		
C6-GYHERM00-M25R	●	R	GYM25RD-E12-040	●	R	E	2.5	40	50	12	27.0	0	79	55.6		
C6-GYHERM00-M25R	●	R	GYM25RD-E12-050	●	R			50	60	12	27.0	0	79	55.6		
C6-GYHERM00-M25R	●	R	GYM25RD-E12-060	●	R			60	75	12	27.0	0	79	55.6		
C6-GYHERM00-M25R	●	R	GYM25RD-E12-075	●	R			75	100	12	27.0	0	79	55.6		
C6-GYHERM00-M25R	●	R	GYM25RD-E12-100	●	R			100	150	12	27.0	0	79	55.6		
C6-GYHERM00-M25R	●	R	GYM25RD-E12-135	●	R			135	200	12	27.0	0	79	55.6		
C6-GYHERM00-M25R	●	R	GYM25RD-E12-180	●	R			180	250	12	27.0	0	79	55.6		
C6-GYHERM00-M25R	●	R	GYM25RD-F12-035	●	R			35	40	12	27.0	0	79	55.6		
C6-GYHERM00-M25R	●	R	GYM25RD-F12-040	●	R			40	50	12	27.0	0	79	55.6		
C6-GYHERM00-M25R	●	R	GYM25RD-F12-050	●	R			50	60	12	27.0	0	79	55.6		
C6-GYHERM00-M25R	●	R	GYM25RD-F12-060	●	R			60	75	12	27.0	0	79	55.6		
C6-GYHERM00-M25R	●	R	GYM25RD-F12-075	●	R			75	100	12	27.0	0	79	55.6		
C6-GYHERM00-M25R	●	R	GYM25RD-F12-100	●	R			100	150	12	27.0	0	79	55.6		
C6-GYHERM00-M25R	●	R	GYM25RD-F12-135	●	R			135	200	12	27.0	0	79	55.6		
C6-GYHERM00-M25R	●	R	GYM25RD-F12-180	●	R	F	3.0	180	250	12	27.0	0	79	55.6		
C6-GYHERM00-M25R	●	R	GYM25RD-F12-225	●	R			225	999	12	27.0	0	79	55.6		
C6-GYHERM00-M25R	●	R	GYM25RD-F20-060	●	R			60	75	20	27.0	0	85	61.6		
C6-GYHERM00-M25R	●	R	GYM25RD-F20-075	●	R			75	100	20	27.0	0	85	61.6		
C6-GYHERM00-M25R	●	R	GYM25RD-F20-100	●	R			100	150	20	27.0	0	85	61.6		
C6-GYHERM00-M25R	●	R	GYM25RD-F20-135	●	R			135	200	20	27.0	0	85	61.6		
C6-GYHERM00-M25R	●	R	GYM25RD-F20-180	●	R			180	250	20	27.0	0	85	61.6		
C6-GYHERM00-M25R	●	R	GYM25RD-F20-225	●	R			225	999	20	27.0	0	85	61.6		
C6-GYHERM00-M25R	●	R	GYM25RD-G14-040	●	R			G	4.0	40	50	14	27.0	0	79	55.6
C6-GYHERM00-M25R	●	R	GYM25RD-G14-050	●	R					50	60	14	27.0	0	79	55.6
C6-GYHERM00-M25R	●	R	GYM25RD-G14-060	●	R					60	85	14	27.0	0	79	55.6
C6-GYHERM00-M25R	●	R	GYM25RD-G14-085	●	R					85	125	14	27.0	0	79	55.6
C6-GYHERM00-M25R	●	R	GYM25RD-G14-125	●	R					125	200	14	27.0	0	79	55.6
C6-GYHERM00-M25R	●	R	GYM25RD-G14-180	●	R					180	280	14	27.0	0	79	55.6
C6-GYHERM00-M25R	●	R	GYM25RD-G14-250	●	R	250	999			14	27.0	0	79	55.6		
C6-GYHERM00-M25R	●	R	GYM25RD-G25-060	●	R	60	85			25	27.0	0	90	66.6		
C6-GYHERM00-M25R	●	R	GYM25RD-G25-085	●	R	85	125			25	27.0	0	90	66.6		
C6-GYHERM00-M25R	●	R	GYM25RD-G25-125	●	R	125	200			25	27.0	0	90	66.6		
C6-GYHERM00-M25R	●	R	GYM25RD-G25-180	●	R	180	280			25	27.0	0	90	66.6		
C6-GYHERM00-M25R	●	R	GYM25RD-G25-250	●	R	250	999			25	27.0	0	90	66.6		
C6-GYHERM00-M25R	●	R	GYM25RD-H14-050	●	R	H	5.0			50	60	14	27.0	0	79	55.6
C6-GYHERM00-M25R	●	R	GYM25RD-H14-060	●	R					60	85	14	27.0	0	79	55.6
C6-GYHERM00-M25R	●	R	GYM25RD-H14-085	●	R			85	125	14	27.0	0	79	55.6		
C6-GYHERM00-M25R	●	R	GYM25RD-H14-125	●	R			125	200	14	27.0	0	79	55.6		
C6-GYHERM00-M25R	●	R	GYM25RD-H14-180	●	R			180	280	14	27.0	0	79	55.6		
C6-GYHERM00-M25R	●	R	GYM25RD-H14-250	●	R			250	999	14	27.0	0	79	55.6		
C6-GYHERM00-M25R	●	R	GYM25RD-H25-060	●	R			60	85	25	27.0	0	90	66.6		
C6-GYHERM00-M25R	●	R	GYM25RD-H25-085	●	R			85	125	25	27.0	0	90	66.6		
C6-GYHERM00-M25R	●	R	GYM25RD-H25-125	●	R			125	200	25	27.0	0	90	66.6		
C6-GYHERM00-M25R	●	R	GYM25RD-H25-180	●	R			180	280	25	27.0	0	90	66.6		
C6-GYHERM00-M25R	●	R	GYM25RD-H25-250	●	R			250	999	25	27.0	0	90	66.6		

Order number Holder	Stock	Hand	Order number Modular blade	Stock	Hand	Seat size	CW	DAXN	DAXX	CDX	WF	HF	LF	LH
C6-GYHERM00-M25R	●	R	GYM25RD-J14-050	●	R	J	6.0	50	70	14	27.0	0	79	55.6
C6-GYHERM00-M25R	●	R	GYM25RD-J14-070	●	R			70	110	14	27.0	0	79	55.6
C6-GYHERM00-M25R	●	R	GYM25RD-J14-110	●	R			110	200	14	27.0	0	79	55.6
C6-GYHERM00-M25R	●	R	GYM25RD-J14-170	●	R			170	280	14	27.0	0	79	55.6
C6-GYHERM00-M25R	●	R	GYM25RD-J14-250	●	R			250	999	14	27.0	0	79	55.6
C6-GYHERM00-M25R	●	R	GYM25RD-J25-070	●	R			70	110	25	27.0	0	90	66.6
C6-GYHERM00-M25R	●	R	GYM25RD-J25-110	●	R			110	200	25	27.0	0	90	66.6
C6-GYHERM00-M25R	●	R	GYM25RD-J25-170	●	R			170	280	25	27.0	0	90	66.6
C6-GYHERM00-M25R	●	R	GYM25RD-J25-250	●	R			250	999	25	27.0	0	90	66.6
C6-GYHELM00-M25L	●	L	GYM25LD-D12-040	●	L			D	2.0	40	50	12	27.0	0
C6-GYHELM00-M25L	●	L	GYM25LD-D12-050	●	L	50	60			12	27.0	0	79	55.6
C6-GYHELM00-M25L	●	L	GYM25LD-D12-060	●	L	60	75			12	27.0	0	79	55.6
C6-GYHELM00-M25L	●	L	GYM25LD-D12-075	●	L	75	100			12	27.0	0	79	55.6
C6-GYHELM00-M25L	●	L	GYM25LD-D12-100	●	L	100	150			12	27.0	0	79	55.6
C6-GYHELM00-M25L	●	L	GYM25LD-D12-135	●	L	135	200			12	27.0	0	79	55.6
C6-GYHELM00-M25L	●	L	GYM25LD-D12-180	●	L	180	250			12	27.0	0	79	55.6
C6-GYHELM00-M25L	●	L	GYM25LD-E12-040	●	L	40	50			12	27.0	0	79	55.6
C6-GYHELM00-M25L	●	L	GYM25LD-E12-050	●	L	50	60			12	27.0	0	79	55.6
C6-GYHELM00-M25L	●	L	GYM25LD-E12-060	●	L	60	75			12	27.0	0	79	55.6
C6-GYHELM00-M25L	●	L	GYM25LD-E12-075	●	L	E	2.5	75	100	12	27.0	0	79	55.6
C6-GYHELM00-M25L	●	L	GYM25LD-E12-100	●	L			100	150	12	27.0	0	79	55.6
C6-GYHELM00-M25L	●	L	GYM25LD-E12-135	●	L			135	200	12	27.0	0	79	55.6
C6-GYHELM00-M25L	●	L	GYM25LD-E12-180	●	L			180	250	12	27.0	0	79	55.6
C6-GYHELM00-M25L	●	L	GYM25LD-F12-035	●	L			35	40	12	27.0	0	79	55.6
C6-GYHELM00-M25L	●	L	GYM25LD-F12-040	●	L			40	50	12	27.0	0	79	55.6
C6-GYHELM00-M25L	●	L	GYM25LD-F12-050	●	L			50	60	12	27.0	0	79	55.6
C6-GYHELM00-M25L	●	L	GYM25LD-F12-060	●	L			60	75	12	27.0	0	79	55.6
C6-GYHELM00-M25L	●	L	GYM25LD-F12-075	●	L			75	100	12	27.0	0	79	55.6
C6-GYHELM00-M25L	●	L	GYM25LD-F12-100	●	L			100	150	12	27.0	0	79	55.6
C6-GYHELM00-M25L	●	L	GYM25LD-F12-135	●	L	F	3.0	135	200	12	27.0	0	79	55.6
C6-GYHELM00-M25L	●	L	GYM25LD-F12-180	●	L			180	250	12	27.0	0	79	55.6
C6-GYHELM00-M25L	●	L	GYM25LD-F12-225	●	L			225	999	12	27.0	0	79	55.6
C6-GYHELM00-M25L	●	L	GYM25LD-F20-060	●	L			60	75	20	27.0	0	85	61.6
C6-GYHELM00-M25L	●	L	GYM25LD-F20-075	●	L			75	100	20	27.0	0	85	61.6
C6-GYHELM00-M25L	●	L	GYM25LD-F20-100	●	L			100	150	20	27.0	0	85	61.6
C6-GYHELM00-M25L	●	L	GYM25LD-F20-135	●	L			135	200	20	27.0	0	85	61.6
C6-GYHELM00-M25L	●	L	GYM25LD-F20-180	●	L			180	250	20	27.0	0	85	61.6
C6-GYHELM00-M25L	●	L	GYM25LD-F20-225	●	L			225	999	20	27.0	0	85	61.6
C6-GYHELM00-M25L	●	L	GYM25LD-G14-040	●	L			40	50	14	27.0	0	79	55.6
C6-GYHELM00-M25L	●	L	GYM25LD-G14-050	●	L	50	60	14	27.0	0	79	55.6		
C6-GYHELM00-M25L	●	L	GYM25LD-G14-060	●	L	60	85	14	27.0	0	79	55.6		
C6-GYHELM00-M25L	●	L	GYM25LD-G14-085	●	L	85	125	14	27.0	0	79	55.6		
C6-GYHELM00-M25L	●	L	GYM25LD-G14-125	●	L	125	200	14	27.0	0	79	55.6		
C6-GYHELM00-M25L	●	L	GYM25LD-G14-180	●	L	G	4.0	180	280	14	27.0	0	79	55.6
C6-GYHELM00-M25L	●	L	GYM25LD-G14-250	●	L			250	999	14	27.0	0	79	55.6
C6-GYHELM00-M25L	●	L	GYM25LD-G25-060	●	L			60	85	25	27.0	0	90	66.6
C6-GYHELM00-M25L	●	L	GYM25LD-G25-085	●	L			85	125	25	27.0	0	90	66.6
C6-GYHELM00-M25L	●	L	GYM25LD-G25-125	●	L			125	200	25	27.0	0	90	66.6
C6-GYHELM00-M25L	●	L	GYM25LD-G25-180	●	L			180	280	25	27.0	0	90	66.6
C6-GYHELM00-M25L	●	L	GYM25LD-G25-250	●	L			250	999	25	27.0	0	90	66.6

GY GROOVING SERIES

FACE GROOVING

00° TYPE HOLDER

Order number Holder	Stock	Hand	Order number Modular blade	Stock	Hand	Seat size	CW	DAXN	DAXX	CDX	WF	HF	LF	LH
C6-GYHELM00-M25L	●	L	GYM25LD-H14-050	●	L	H	5.0	50	60	14	27.0	0	79	55.6
C6-GYHELM00-M25L	●	L	GYM25LD-H14-060	●	L			60	85	14	27.0	0	79	55.6
C6-GYHELM00-M25L	●	L	GYM25LD-H14-085	●	L			85	125	14	27.0	0	79	55.6
C6-GYHELM00-M25L	●	L	GYM25LD-H14-125	●	L			125	200	14	27.0	0	79	55.6
C6-GYHELM00-M25L	●	L	GYM25LD-H14-180	●	L			180	280	14	27.0	0	79	55.6
C6-GYHELM00-M25L	●	L	GYM25LD-H14-250	●	L			250	999	14	27.0	0	79	55.6
C6-GYHELM00-M25L	●	L	GYM25LD-H25-060	●	L			60	85	25	27.0	0	90	66.6
C6-GYHELM00-M25L	●	L	GYM25LD-H25-085	●	L			85	125	25	27.0	0	90	66.6
C6-GYHELM00-M25L	●	L	GYM25LD-H25-125	●	L			125	200	25	27.0	0	90	66.6
C6-GYHELM00-M25L	●	L	GYM25LD-H25-180	●	L			180	280	25	27.0	0	90	66.6
C6-GYHELM00-M25L	●	L	GYM25LD-H25-250	●	L	250	999	25	27.0	0	90	66.6		
C6-GYHELM00-M25L	●	L	GYM25LD-J14-050	●	L	J	6.0	50	70	14	27.0	0	79	55.6
C6-GYHELM00-M25L	●	L	GYM25LD-J14-070	●	L			70	110	14	27.0	0	79	55.6
C6-GYHELM00-M25L	●	L	GYM25LD-J14-110	●	L			110	200	14	27.0	0	79	55.6
C6-GYHELM00-M25L	●	L	GYM25LD-J14-170	●	L			170	280	14	27.0	0	79	55.6
C6-GYHELM00-M25L	●	L	GYM25LD-J14-250	●	L			250	999	14	27.0	0	79	55.6
C6-GYHELM00-M25L	●	L	GYM25LD-J25-070	●	L			70	110	25	27.0	0	90	66.6
C6-GYHELM00-M25L	●	L	GYM25LD-J25-110	●	L			110	200	25	27.0	0	90	66.6
C6-GYHELM00-M25L	●	L	GYM25LD-J25-170	●	L			170	280	25	27.0	0	90	66.6
C6-GYHELM00-M25L	●	L	GYM25LD-J25-250	●	L			250	999	25	27.0	0	90	66.6

1. The indicated dimensions are values for standard inserts (GM breakers). If other inserts are mounted, LF and LH may differ. Select the inserts and recommended conditions from "Brochure B140".



GY GROOVING SERIES

FACE GROOVING

90° TYPE HOLDER

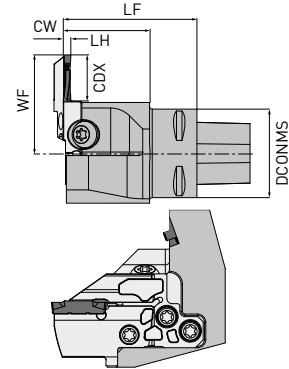

Right hand tool holder shown.

- Please order the modular blade and modular holder separately.
- Please set a right hand modular blade on a right hand holder and a left hand modular blade on a left hand holder.

Order number	Stock	Hand		Mounting size	DCONMS	CW
C4-GYHERM00-M25R	●	R	✓	PSC40	40	2.0-6.35
C4-GYHELM00-M25L	●	L	✓	PSC40	40	2.0-6.35
C5-GYHERM00-M25R	●	R	✓	PSC50	50	2.0-6.35
C5-GYHELM00-M25L	●	L	✓	PSC50	50	2.0-6.35
C6-GYHERM00-M25R	●	R	✓	PSC63	60	2.0-6.35
C6-GYHELM00-M25L	●	L	✓	PSC63	60	2.0-6.35

SET DIMENSIONS WITH MODULAR BLADES

Order number Holder	Stock	Hand	Order number Modular blade	Stock	Hand	Seat size	CW	DAXN	DAXX	CDX	WF	HF	LF	LH
C4-GYHERM90-M25L	●	R	GYM25LD-D12-040	●	L	D	2.0	40	50	12	38.5	0	60	38.6
C4-GYHERM90-M25L	●	R	GYM25LD-D12-050	●	L			50	60	12	38.5	0	60	38.6
C4-GYHERM90-M25L	●	R	GYM25LD-D12-060	●	L			60	75	12	38.5	0	60	38.6
C4-GYHERM90-M25L	●	R	GYM25LD-D12-075	●	L			75	100	12	38.5	0	60	38.6
C4-GYHERM90-M25L	●	R	GYM25LD-D12-100	●	L			100	150	12	38.5	0	60	38.6
C4-GYHERM90-M25L	●	R	GYM25LD-D12-135	●	L			135	200	12	38.5	0	60	38.6
C4-GYHERM90-M25L	●	R	GYM25LD-D12-180	●	L			180	250	12	38.5	0	60	38.6
C4-GYHERM90-M25L	●	R	GYM25LD-E12-040	●	L	E	2.5	40	50	12	38.5	0	60	38.6
C4-GYHERM90-M25L	●	R	GYM25LD-E12-050	●	L			50	60	12	38.5	0	60	38.6
C4-GYHERM90-M25L	●	R	GYM25LD-E12-060	●	L			60	75	12	38.5	0	60	38.6
C4-GYHERM90-M25L	●	R	GYM25LD-E12-075	●	L			75	100	12	38.5	0	60	38.6
C4-GYHERM90-M25L	●	R	GYM25LD-E12-100	●	L			100	150	12	38.5	0	60	38.6
C4-GYHERM90-M25L	●	R	GYM25LD-E12-135	●	L			135	200	12	38.5	0	60	38.6
C4-GYHERM90-M25L	●	R	GYM25LD-E12-180	●	L			180	250	12	38.5	0	60	38.6

GY GROOVING SERIES

FACE GROOVING

90° TYPE HOLDER

Order number Holder	Stock	Hand	Order number Modular blade	Stock	Hand	Seat size	CW	DAXN	DAXX	CDX	WF	HF	LF	LH		
C4-GYHERM90-M25L	●	R	GYM25LD-F12-035	●	L	F	3.0	35	40	12	38.5	0	60	38.6		
C4-GYHERM90-M25L	●	R	GYM25LD-F12-040	●	L			40	50	12	38.5	0	60	38.6		
C4-GYHERM90-M25L	●	R	GYM25LD-F12-050	●	L			50	60	12	38.5	0	60	38.6		
C4-GYHERM90-M25L	●	R	GYM25LD-F12-060	●	L			60	75	12	38.5	0	60	38.6		
C4-GYHERM90-M25L	●	R	GYM25LD-F12-075	●	L			75	100	12	38.5	0	60	38.6		
C4-GYHERM90-M25L	●	R	GYM25LD-F12-100	●	L			100	150	12	38.5	0	60	38.6		
C4-GYHERM90-M25L	●	R	GYM25LD-F12-135	●	L			135	200	12	38.5	0	60	38.6		
C4-GYHERM90-M25L	●	R	GYM25LD-F12-180	●	L			180	250	12	38.5	0	60	38.6		
C4-GYHERM90-M25L	●	R	GYM25LD-F12-225	●	L			225	999	12	38.5	0	60	38.6		
C4-GYHERM90-M25L	●	R	GYM25LD-F20-060	●	L			60	75	20	44.5	0	60	38.6		
C4-GYHERM90-M25L	●	R	GYM25LD-F20-075	●	L			75	100	20	44.5	0	60	38.6		
C4-GYHERM90-M25L	●	R	GYM25LD-F20-100	●	L			100	150	20	44.5	0	60	38.6		
C4-GYHERM90-M25L	●	R	GYM25LD-F20-135	●	L			135	200	20	44.5	0	60	38.6		
C4-GYHERM90-M25L	●	R	GYM25LD-F20-180	●	L			180	250	20	44.5	0	60	38.6		
C4-GYHERM90-M25L	●	R	GYM25LD-F20-225	●	L			225	999	20	44.5	0	60	38.6		
C4-GYHERM90-M25L	●	R	GYM25LD-G14-040	●	L			G	4.0	40	50	14	38.5	0	60	38.6
C4-GYHERM90-M25L	●	R	GYM25LD-G14-050	●	L	50	60			14	38.5	0	60	38.6		
C4-GYHERM90-M25L	●	R	GYM25LD-G14-060	●	L	60	85			14	38.5	0	60	38.6		
C4-GYHERM90-M25L	●	R	GYM25LD-G14-085	●	L	85	125			14	38.5	0	60	38.6		
C4-GYHERM90-M25L	●	R	GYM25LD-G14-125	●	L	125	200			14	38.5	0	60	38.6		
C4-GYHERM90-M25L	●	R	GYM25LD-G14-180	●	L	180	280			14	38.5	0	60	38.6		
C4-GYHERM90-M25L	●	R	GYM25LD-G14-250	●	L	250	999			14	38.5	0	60	38.6		
C4-GYHERM90-M25L	●	R	GYM25LD-G25-060	●	L	60	85			25	49.5	0	60	38.6		
C4-GYHERM90-M25L	●	R	GYM25LD-G25-085	●	L	85	125			25	49.5	0	60	38.6		
C4-GYHERM90-M25L	●	R	GYM25LD-G25-125	●	L	125	200			25	49.5	0	60	38.6		
C4-GYHERM90-M25L	●	R	GYM25LD-G25-180	●	L	180	280			25	49.5	0	60	38.6		
C4-GYHERM90-M25L	●	R	GYM25LD-G25-250	●	L	250	999			25	49.5	0	60	38.6		
C4-GYHERM90-M25L	●	R	GYM25LD-H14-050	●	L	H	5.0			50	60	14	38.5	0	60	38.6
C4-GYHERM90-M25L	●	R	GYM25LD-H14-060	●	L					60	85	14	38.5	0	60	38.6
C4-GYHERM90-M25L	●	R	GYM25LD-H14-085	●	L					85	125	14	38.5	0	60	38.6
C4-GYHERM90-M25L	●	R	GYM25LD-H14-125	●	L					125	200	14	38.5	0	60	38.6
C4-GYHERM90-M25L	●	R	GYM25LD-H14-180	●	L			180	280	14	38.5	0	60	38.6		
C4-GYHERM90-M25L	●	R	GYM25LD-H14-250	●	L			250	999	14	38.5	0	60	38.6		
C4-GYHERM90-M25L	●	R	GYM25LD-H25-060	●	L			60	85	25	49.5	0	60	38.6		
C4-GYHERM90-M25L	●	R	GYM25LD-H25-085	●	L			85	125	25	49.5	0	60	38.6		
C4-GYHERM90-M25L	●	R	GYM25LD-H25-125	●	L			125	200	25	49.5	0	60	38.6		
C4-GYHERM90-M25L	●	R	GYM25LD-H25-180	●	L			180	280	25	49.5	0	60	38.6		
C4-GYHERM90-M25L	●	R	GYM25LD-H25-250	●	L			250	999	25	49.5	0	60	38.6		
C4-GYHERM90-M25L	●	R	GYM25LD-J14-050	●	L			J	6.0	50	70	14	38.5	0	60	38.6
C4-GYHERM90-M25L	●	R	GYM25LD-J14-070	●	L					70	110	14	38.5	0	60	38.6
C4-GYHERM90-M25L	●	R	GYM25LD-J14-110	●	L					110	200	14	38.5	0	60	38.6
C4-GYHERM90-M25L	●	R	GYM25LD-J14-170	●	L					170	280	14	38.5	0	60	38.6
C4-GYHERM90-M25L	●	R	GYM25LD-J14-250	●	L					250	999	14	38.5	0	60	38.6
C4-GYHERM90-M25L	●	R	GYM25LD-J25-070	●	L	70	110			25	49.5	0	60	38.6		
C4-GYHERM90-M25L	●	R	GYM25LD-J25-110	●	L	110	200			25	49.5	0	60	38.6		
C4-GYHERM90-M25L	●	R	GYM25LD-J25-170	●	L	170	280			25	49.5	0	60	38.6		
C4-GYHERM90-M25L	●	R	GYM25LD-J25-250	●	L	250	999			25	49.5	0	60	38.6		

Order number Holder	Stock	Hand	Order number Modular blade	Stock	Hand	Seat size	CW	DAXN	DAXX	CDX	WF	HF	LF	LH		
C4-GYHELM90-M25R	●	L	GYM25RD-D12-040	●	R	D	2.0	40	50	12	38.5	0	60	38.6		
C4-GYHELM90-M25R	●	L	GYM25RD-D12-050	●	R			50	60	12	38.5	0	60	38.6		
C4-GYHELM90-M25R	●	L	GYM25RD-D12-060	●	R			60	75	12	38.5	0	60	38.6		
C4-GYHELM90-M25R	●	L	GYM25RD-D12-075	●	R			75	100	12	38.5	0	60	38.6		
C4-GYHELM90-M25R	●	L	GYM25RD-D12-100	●	R			100	150	12	38.5	0	60	38.6		
C4-GYHELM90-M25R	●	L	GYM25RD-D12-135	●	R			135	200	12	38.5	0	60	38.6		
C4-GYHELM90-M25R	●	L	GYM25RD-D12-180	●	R			180	250	12	38.5	0	60	38.6		
C4-GYHELM90-M25R	●	L	GYM25RD-E12-040	●	R	E	2.5	40	50	12	38.5	0	60	38.6		
C4-GYHELM90-M25R	●	L	GYM25RD-E12-050	●	R			50	60	12	38.5	0	60	38.6		
C4-GYHELM90-M25R	●	L	GYM25RD-E12-060	●	R			60	75	12	38.5	0	60	38.6		
C4-GYHELM90-M25R	●	L	GYM25RD-E12-075	●	R			75	100	12	38.5	0	60	38.6		
C4-GYHELM90-M25R	●	L	GYM25RD-E12-100	●	R			100	150	12	38.5	0	60	38.6		
C4-GYHELM90-M25R	●	L	GYM25RD-E12-135	●	R			135	200	12	38.5	0	60	38.6		
C4-GYHELM90-M25R	●	L	GYM25RD-E12-180	●	R			180	250	12	38.5	0	60	38.6		
C4-GYHELM90-M25R	●	L	GYM25RD-F12-035	●	R	F	3.0	35	40	12	38.5	0	60	38.6		
C4-GYHELM90-M25R	●	L	GYM25RD-F12-040	●	R			40	50	12	38.5	0	60	38.6		
C4-GYHELM90-M25R	●	L	GYM25RD-F12-050	●	R			50	60	12	38.5	0	60	38.6		
C4-GYHELM90-M25R	●	L	GYM25RD-F12-060	●	R			60	75	12	38.5	0	60	38.6		
C4-GYHELM90-M25R	●	L	GYM25RD-F12-075	●	R			75	100	12	38.5	0	60	38.6		
C4-GYHELM90-M25R	●	L	GYM25RD-F12-100	●	R			100	150	12	38.5	0	60	38.6		
C4-GYHELM90-M25R	●	L	GYM25RD-F12-135	●	R			135	200	12	38.5	0	60	38.6		
C4-GYHELM90-M25R	●	L	GYM25RD-F12-180	●	R			180	250	12	38.5	0	60	38.6		
C4-GYHELM90-M25R	●	L	GYM25RD-F12-225	●	R			225	999	12	38.5	0	60	38.6		
C4-GYHELM90-M25R	●	L	GYM25RD-F20-060	●	R			60	75	20	44.5	0	60	38.6		
C4-GYHELM90-M25R	●	L	GYM25RD-F20-075	●	R			75	100	20	44.5	0	60	38.6		
C4-GYHELM90-M25R	●	L	GYM25RD-F20-100	●	R			100	150	20	44.5	0	60	38.6		
C4-GYHELM90-M25R	●	L	GYM25RD-F20-135	●	R			135	200	20	44.5	0	60	38.6		
C4-GYHELM90-M25R	●	L	GYM25RD-F20-180	●	R			180	250	20	44.5	0	60	38.6		
C4-GYHELM90-M25R	●	L	GYM25RD-F20-225	●	R			225	999	20	44.5	0	60	38.6		
C4-GYHELM90-M25R	●	L	GYM25RD-G14-040	●	R			G	4.0	40	50	14	38.5	0	60	38.6
C4-GYHELM90-M25R	●	L	GYM25RD-G14-050	●	R					50	60	14	38.5	0	60	38.6
C4-GYHELM90-M25R	●	L	GYM25RD-G14-060	●	R	60	85			14	38.5	0	60	38.6		
C4-GYHELM90-M25R	●	L	GYM25RD-G14-085	●	R	85	125			14	38.5	0	60	38.6		
C4-GYHELM90-M25R	●	L	GYM25RD-G14-125	●	R	125	200			14	38.5	0	60	38.6		
C4-GYHELM90-M25R	●	L	GYM25RD-G14-180	●	R	180	280			14	38.5	0	60	38.6		
C4-GYHELM90-M25R	●	L	GYM25RD-G14-250	●	R	250	999			14	38.5	0	60	38.6		
C4-GYHELM90-M25R	●	L	GYM25RD-G25-060	●	R	60	85			25	49.5	0	60	38.6		
C4-GYHELM90-M25R	●	L	GYM25RD-G25-085	●	R	85	125			25	49.5	0	60	38.6		
C4-GYHELM90-M25R	●	L	GYM25RD-G25-125	●	R	125	200			25	49.5	0	60	38.6		
C4-GYHELM90-M25R	●	L	GYM25RD-G25-180	●	R	180	280			25	49.5	0	60	38.6		
C4-GYHELM90-M25R	●	L	GYM25RD-G25-250	●	R	250	999			25	49.5	0	60	38.6		
C4-GYHELM90-M25R	●	L	GYM25RD-H14-050	●	R	H	5.0			50	60	14	38.5	0	60	38.6
C4-GYHELM90-M25R	●	L	GYM25RD-H14-060	●	R			60	85	14	38.5	0	60	38.6		
C4-GYHELM90-M25R	●	L	GYM25RD-H14-085	●	R			85	125	14	38.5	0	60	38.6		
C4-GYHELM90-M25R	●	L	GYM25RD-H14-125	●	R			125	200	14	38.5	0	60	38.6		
C4-GYHELM90-M25R	●	L	GYM25RD-H14-180	●	R			180	280	14	38.5	0	60	38.6		
C4-GYHELM90-M25R	●	L	GYM25RD-H14-250	●	R			250	999	14	38.5	0	60	38.6		
C4-GYHELM90-M25R	●	L	GYM25RD-H25-060	●	R			60	85	25	49.5	0	60	38.6		
C4-GYHELM90-M25R	●	L	GYM25RD-H25-085	●	R			85	125	25	49.5	0	60	38.6		
C4-GYHELM90-M25R	●	L	GYM25RD-H25-125	●	R			125	200	25	49.5	0	60	38.6		
C4-GYHELM90-M25R	●	L	GYM25RD-H25-180	●	R			180	280	25	49.5	0	60	38.6		
C4-GYHELM90-M25R	●	L	GYM25RD-H25-250	●	R			250	999	25	49.5	0	60	38.6		

GY GROOVING SERIES

FACE GROOVING

90° TYPE HOLDER

Order number Holder	Stock	Hand	Order number Modular blade	Stock	Hand	Seat size	CW	DAXN	DAXX	CDX	WF	HF	LF	LH
C4-GYHELM90-M25R	●	L	GYM25RD-J14-050	●	R	J	6.0	50	70	14	38.5	0	60	38.6
C4-GYHELM90-M25R	●	L	GYM25RD-J14-070	●	R			70	110	14	38.5	0	60	38.6
C4-GYHELM90-M25R	●	L	GYM25RD-J14-110	●	R			110	200	14	38.5	0	60	38.6
C4-GYHELM90-M25R	●	L	GYM25RD-J14-170	●	R			170	280	14	38.5	0	60	38.6
C4-GYHELM90-M25R	●	L	GYM25RD-J14-250	●	R			250	999	14	38.5	0	60	38.6
C4-GYHELM90-M25R	●	L	GYM25RD-J25-070	●	R			70	110	25	49.5	0	60	38.6
C4-GYHELM90-M25R	●	L	GYM25RD-J25-110	●	R			110	200	25	49.5	0	60	38.6
C4-GYHELM90-M25R	●	L	GYM25RD-J25-170	●	R			170	280	25	49.5	0	60	38.6
C4-GYHELM90-M25R	●	L	GYM25RD-J25-250	●	R			250	999	25	49.5	0	60	38.6
C5-GYHERM90-M25L	●	R	GYM25LD-D12-040	●	L			D	2.0	40	50	12	41.0	0
C5-GYHERM90-M25L	●	R	GYM25LD-D12-050	●	L	50	60			12	41.0	0	60	38.6
C5-GYHERM90-M25L	●	R	GYM25LD-D12-060	●	L	60	75			12	41.0	0	60	38.6
C5-GYHERM90-M25L	●	R	GYM25LD-D12-075	●	L	75	100			12	41.0	0	60	38.6
C5-GYHERM90-M25L	●	R	GYM25LD-D12-100	●	L	100	150			12	41.0	0	60	38.6
C5-GYHERM90-M25L	●	R	GYM25LD-D12-135	●	L	135	200			12	41.0	0	60	38.6
C5-GYHERM90-M25L	●	R	GYM25LD-D12-180	●	L	180	250			12	41.0	0	60	38.6
C5-GYHERM90-M25L	●	R	GYM25LD-E12-040	●	L	40	50			12	41.0	0	60	38.6
C5-GYHERM90-M25L	●	R	GYM25LD-E12-050	●	L	50	60			12	41.0	0	60	38.6
C5-GYHERM90-M25L	●	R	GYM25LD-E12-060	●	L	60	75			12	41.0	0	60	38.6
C5-GYHERM90-M25L	●	R	GYM25LD-E12-075	●	L	E	2.5	75	100	12	41.0	0	60	38.6
C5-GYHERM90-M25L	●	R	GYM25LD-E12-100	●	L			100	150	12	41.0	0	60	38.6
C5-GYHERM90-M25L	●	R	GYM25LD-E12-135	●	L			135	200	12	41.0	0	60	38.6
C5-GYHERM90-M25L	●	R	GYM25LD-E12-180	●	L			180	250	12	41.0	0	60	38.6
C5-GYHERM90-M25L	●	R	GYM25LD-F12-035	●	L			35	40	12	41.0	0	60	38.6
C5-GYHERM90-M25L	●	R	GYM25LD-F12-040	●	L			40	50	12	41.0	0	60	38.6
C5-GYHERM90-M25L	●	R	GYM25LD-F12-050	●	L			50	60	12	41.0	0	60	38.6
C5-GYHERM90-M25L	●	R	GYM25LD-F12-060	●	L			60	75	12	41.0	0	60	38.6
C5-GYHERM90-M25L	●	R	GYM25LD-F12-075	●	L			75	100	12	41.0	0	60	38.6
C5-GYHERM90-M25L	●	R	GYM25LD-F12-100	●	L			100	150	12	41.0	0	60	38.6
C5-GYHERM90-M25L	●	R	GYM25LD-F12-135	●	L	F	3.0	135	200	12	41.0	0	60	38.6
C5-GYHERM90-M25L	●	R	GYM25LD-F12-180	●	L			180	250	12	41.0	0	60	38.6
C5-GYHERM90-M25L	●	R	GYM25LD-F12-225	●	L			225	999	12	41.0	0	60	38.6
C5-GYHERM90-M25L	●	R	GYM25LD-F20-060	●	L			60	75	20	47.0	0	60	38.6
C5-GYHERM90-M25L	●	R	GYM25LD-F20-075	●	L			75	100	20	47.0	0	60	38.6
C5-GYHERM90-M25L	●	R	GYM25LD-F20-100	●	L			100	150	20	47.0	0	60	38.6
C5-GYHERM90-M25L	●	R	GYM25LD-F20-135	●	L			135	200	20	47.0	0	60	38.6
C5-GYHERM90-M25L	●	R	GYM25LD-F20-180	●	L			180	250	20	47.0	0	60	38.6
C5-GYHERM90-M25L	●	R	GYM25LD-F20-225	●	L			225	999	20	47.0	0	60	38.6

Order number Holder	Stock	Hand	Order number Modular blade	Stock	Hand	Seat size	CW	DAXN	DAXX	CDX	WF	HF	LF	LH		
C5-GYHERM90-M25L	●	R	GYM25LD-G14-040	●	L	G	4.0	40	50	14	41.0	0	60	38.6		
C5-GYHERM90-M25L	●	R	GYM25LD-G14-050	●	L			50	60	14	41.0	0	60	38.6		
C5-GYHERM90-M25L	●	R	GYM25LD-G14-060	●	L			60	85	14	41.0	0	60	38.6		
C5-GYHERM90-M25L	●	R	GYM25LD-G14-085	●	L			85	125	14	41.0	0	60	38.6		
C5-GYHERM90-M25L	●	R	GYM25LD-G14-125	●	L			125	200	14	41.0	0	60	38.6		
C5-GYHERM90-M25L	●	R	GYM25LD-G14-180	●	L			180	280	14	41.0	0	60	38.6		
C5-GYHERM90-M25L	●	R	GYM25LD-G14-250	●	L			250	999	14	41.0	0	60	38.6		
C5-GYHERM90-M25L	●	R	GYM25LD-G25-060	●	L			60	85	25	52.0	0	60	38.6		
C5-GYHERM90-M25L	●	R	GYM25LD-G25-085	●	L			85	125	25	52.0	0	60	38.6		
C5-GYHERM90-M25L	●	R	GYM25LD-G25-125	●	L			125	200	25	52.0	0	60	38.6		
C5-GYHERM90-M25L	●	R	GYM25LD-G25-180	●	L			180	280	25	52.0	0	60	38.6		
C5-GYHERM90-M25L	●	R	GYM25LD-G25-250	●	L			250	999	25	52.0	0	60	38.6		
C5-GYHERM90-M25L	●	R	GYM25LD-H14-050	●	L	H	5.0	50	60	14	41.0	0	60	38.6		
C5-GYHERM90-M25L	●	R	GYM25LD-H14-060	●	L			60	85	14	41.0	0	60	38.6		
C5-GYHERM90-M25L	●	R	GYM25LD-H14-085	●	L			85	125	14	41.0	0	60	38.6		
C5-GYHERM90-M25L	●	R	GYM25LD-H14-125	●	L			125	200	14	41.0	0	60	38.6		
C5-GYHERM90-M25L	●	R	GYM25LD-H14-180	●	L			180	280	14	41.0	0	60	38.6		
C5-GYHERM90-M25L	●	R	GYM25LD-H14-250	●	L			250	999	14	41.0	0	60	38.6		
C5-GYHERM90-M25L	●	R	GYM25LD-H25-060	●	L			60	85	25	52.0	0	60	38.6		
C5-GYHERM90-M25L	●	R	GYM25LD-H25-085	●	L			85	125	25	52.0	0	60	38.6		
C5-GYHERM90-M25L	●	R	GYM25LD-H25-125	●	L			125	200	25	52.0	0	60	38.6		
C5-GYHERM90-M25L	●	R	GYM25LD-H25-180	●	L			180	280	25	52.0	0	60	38.6		
C5-GYHERM90-M25L	●	R	GYM25LD-H25-250	●	L			250	999	25	52.0	0	60	38.6		
C5-GYHERM90-M25L	●	R	GYM25LD-J14-050	●	L			J	6.0	50	70	14	41.0	0	60	38.6
C5-GYHERM90-M25L	●	R	GYM25LD-J14-070	●	L	70	110			14	41.0	0	60	38.6		
C5-GYHERM90-M25L	●	R	GYM25LD-J14-110	●	L	110	200			14	41.0	0	60	38.6		
C5-GYHERM90-M25L	●	R	GYM25LD-J14-170	●	L	170	280			14	41.0	0	60	38.6		
C5-GYHERM90-M25L	●	R	GYM25LD-J14-250	●	L	250	999			14	41.0	0	60	38.6		
C5-GYHERM90-M25L	●	R	GYM25LD-J25-070	●	L	70	110			25	52.0	0	60	38.6		
C5-GYHERM90-M25L	●	R	GYM25LD-J25-110	●	L	110	200			25	52.0	0	60	38.6		
C5-GYHERM90-M25L	●	R	GYM25LD-J25-170	●	L	170	280			25	52.0	0	60	38.6		
C5-GYHERM90-M25L	●	R	GYM25LD-J25-250	●	L	250	999			25	52.0	0	60	38.6		
C5-GYHELM90-M25R	●	L	GYM25RD-D12-040	●	R	D	2.0			40	50	12	41.0	0	60	38.6
C5-GYHELM90-M25R	●	L	GYM25RD-D12-050	●	R					50	60	12	41.0	0	60	38.6
C5-GYHELM90-M25R	●	L	GYM25RD-D12-060	●	R					60	75	12	41.0	0	60	38.6
C5-GYHELM90-M25R	●	L	GYM25RD-D12-075	●	R			75	100	12	41.0	0	60	38.6		
C5-GYHELM90-M25R	●	L	GYM25RD-D12-100	●	R			100	150	12	41.0	0	60	38.6		
C5-GYHELM90-M25R	●	L	GYM25RD-D12-135	●	R			135	200	12	41.0	0	60	38.6		
C5-GYHELM90-M25R	●	L	GYM25RD-D12-180	●	R			180	250	12	41.0	0	60	38.6		
C5-GYHELM90-M25R	●	L	GYM25RD-E12-040	●	R			E	2.5	40	50	12	41.0	0	60	38.6
C5-GYHELM90-M25R	●	L	GYM25RD-E12-050	●	R					50	60	12	41.0	0	60	38.6
C5-GYHELM90-M25R	●	L	GYM25RD-E12-060	●	R					60	75	12	41.0	0	60	38.6
C5-GYHELM90-M25R	●	L	GYM25RD-E12-075	●	R					75	100	12	41.0	0	60	38.6
C5-GYHELM90-M25R	●	L	GYM25RD-E12-100	●	R					100	150	12	41.0	0	60	38.6
C5-GYHELM90-M25R	●	L	GYM25RD-E12-135	●	R	135	200			12	41.0	0	60	38.6		
C5-GYHELM90-M25R	●	L	GYM25RD-E12-180	●	R	180	250			12	41.0	0	60	38.6		

GY GROOVING SERIES

FACE GROOVING

90° TYPE HOLDER

Order number Holder	Stock	Hand	Order number Modular blade	Stock	Hand	Seat size	CW	DAXN	DAXX	CDX	WF	HF	LF	LH		
C5-GYHELM90-M25R	●	L	GYM25RD-F12-035	●	R	F	3.0	35	40	12	41.0	0	60	38.6		
C5-GYHELM90-M25R	●	L	GYM25RD-F12-040	●	R			40	50	12	41.0	0	60	38.6		
C5-GYHELM90-M25R	●	L	GYM25RD-F12-050	●	R			50	60	12	41.0	0	60	38.6		
C5-GYHELM90-M25R	●	L	GYM25RD-F12-060	●	R			60	75	12	41.0	0	60	38.6		
C5-GYHELM90-M25R	●	L	GYM25RD-F12-075	●	R			75	100	12	41.0	0	60	38.6		
C5-GYHELM90-M25R	●	L	GYM25RD-F12-100	●	R			100	150	12	41.0	0	60	38.6		
C5-GYHELM90-M25R	●	L	GYM25RD-F12-135	●	R			135	200	12	41.0	0	60	38.6		
C5-GYHELM90-M25R	●	L	GYM25RD-F12-180	●	R			180	250	12	41.0	0	60	38.6		
C5-GYHELM90-M25R	●	L	GYM25RD-F12-225	●	R			225	999	12	41.0	0	60	38.6		
C5-GYHELM90-M25R	●	L	GYM25RD-F20-060	●	R			60	75	20	47.0	0	60	38.6		
C5-GYHELM90-M25R	●	L	GYM25RD-F20-075	●	R			75	100	20	47.0	0	60	38.6		
C5-GYHELM90-M25R	●	L	GYM25RD-F20-100	●	R			100	150	20	47.0	0	60	38.6		
C5-GYHELM90-M25R	●	L	GYM25RD-F20-135	●	R			135	200	20	47.0	0	60	38.6		
C5-GYHELM90-M25R	●	L	GYM25RD-F20-180	●	R			180	250	20	47.0	0	60	38.6		
C5-GYHELM90-M25R	●	L	GYM25RD-F20-225	●	R			225	999	20	47.0	0	60	38.6		
C5-GYHELM90-M25R	●	L	GYM25RD-G14-040	●	R			G	4.0	40	50	14	41.0	0	60	38.6
C5-GYHELM90-M25R	●	L	GYM25RD-G14-050	●	R	50	60			14	41.0	0	60	38.6		
C5-GYHELM90-M25R	●	L	GYM25RD-G14-060	●	R	60	85			14	41.0	0	60	38.6		
C5-GYHELM90-M25R	●	L	GYM25RD-G14-085	●	R	85	125			14	41.0	0	60	38.6		
C5-GYHELM90-M25R	●	L	GYM25RD-G14-125	●	R	125	200			14	41.0	0	60	38.6		
C5-GYHELM90-M25R	●	L	GYM25RD-G14-180	●	R	180	280			14	41.0	0	60	38.6		
C5-GYHELM90-M25R	●	L	GYM25RD-G14-250	●	R	250	999			14	41.0	0	60	38.6		
C5-GYHELM90-M25R	●	L	GYM25RD-G25-060	●	R	60	85			25	52.0	0	60	38.6		
C5-GYHELM90-M25R	●	L	GYM25RD-G25-085	●	R	85	125			25	52.0	0	60	38.6		
C5-GYHELM90-M25R	●	L	GYM25RD-G25-125	●	R	125	200			25	52.0	0	60	38.6		
C5-GYHELM90-M25R	●	L	GYM25RD-G25-180	●	R	180	280			25	52.0	0	60	38.6		
C5-GYHELM90-M25R	●	L	GYM25RD-G25-250	●	R	250	999			25	52.0	0	60	38.6		
C5-GYHELM90-M25R	●	L	GYM25RD-H14-050	●	R	H	5.0			50	60	14	41.0	0	60	38.6
C5-GYHELM90-M25R	●	L	GYM25RD-H14-060	●	R					60	85	14	41.0	0	60	38.6
C5-GYHELM90-M25R	●	L	GYM25RD-H14-085	●	R					85	125	14	41.0	0	60	38.6
C5-GYHELM90-M25R	●	L	GYM25RD-H14-125	●	R					125	200	14	41.0	0	60	38.6
C5-GYHELM90-M25R	●	L	GYM25RD-H14-180	●	R			180	280	14	41.0	0	60	38.6		
C5-GYHELM90-M25R	●	L	GYM25RD-H14-250	●	R			250	999	14	41.0	0	60	38.6		
C5-GYHELM90-M25R	●	L	GYM25RD-H25-060	●	R			60	85	25	52.0	0	60	38.6		
C5-GYHELM90-M25R	●	L	GYM25RD-H25-085	●	R			85	125	25	52.0	0	60	38.6		
C5-GYHELM90-M25R	●	L	GYM25RD-H25-125	●	R			125	200	25	52.0	0	60	38.6		
C5-GYHELM90-M25R	●	L	GYM25RD-H25-180	●	R			180	280	25	52.0	0	60	38.6		
C5-GYHELM90-M25R	●	L	GYM25RD-H25-250	●	R			250	999	25	52.0	0	60	38.6		
C5-GYHELM90-M25R	●	L	GYM25RD-J14-050	●	R			J	6.0	50	70	14	41.0	0	60	38.6
C5-GYHELM90-M25R	●	L	GYM25RD-J14-070	●	R					70	110	14	41.0	0	60	38.6
C5-GYHELM90-M25R	●	L	GYM25RD-J14-110	●	R					110	200	14	41.0	0	60	38.6
C5-GYHELM90-M25R	●	L	GYM25RD-J14-170	●	R					170	280	14	41.0	0	60	38.6
C5-GYHELM90-M25R	●	L	GYM25RD-J14-250	●	R					250	999	14	41.0	0	60	38.6
C5-GYHELM90-M25R	●	L	GYM25RD-J25-070	●	R	70	110			25	52.0	0	60	38.6		
C5-GYHELM90-M25R	●	L	GYM25RD-J25-110	●	R	110	200			25	52.0	0	60	38.6		
C5-GYHELM90-M25R	●	L	GYM25RD-J25-170	●	R	170	280			25	52.0	0	60	38.6		
C5-GYHELM90-M25R	●	L	GYM25RD-J25-250	●	R	250	999			25	52.0	0	60	38.6		

Order number Holder	Stock	Hand	Order number Modular blade	Stock	Hand	Seat size	CW	DAXN	DAXX	CDX	WF	HF	LF	LH		
C6-GYHERM90-M25L	●	R	GYM25LD-D12-040	●	L	D	2.0	40	50	12	48.0	0	70	46.6		
C6-GYHERM90-M25L	●	R	GYM25LD-D12-050	●	L			50	60	12	48.0	0	70	46.6		
C6-GYHERM90-M25L	●	R	GYM25LD-D12-060	●	L			60	75	12	48.0	0	70	46.6		
C6-GYHERM90-M25L	●	R	GYM25LD-D12-075	●	L			75	100	12	48.0	0	70	46.6		
C6-GYHERM90-M25L	●	R	GYM25LD-D12-100	●	L			100	150	12	48.0	0	70	46.6		
C6-GYHERM90-M25L	●	R	GYM25LD-D12-135	●	L			135	200	12	48.0	0	70	46.6		
C6-GYHERM90-M25L	●	R	GYM25LD-D12-180	●	L			180	250	12	48.0	0	70	46.6		
C6-GYHERM90-M25L	●	R	GYM25LD-E12-040	●	L	E	2.5	40	50	12	48.0	0	70	46.6		
C6-GYHERM90-M25L	●	R	GYM25LD-E12-050	●	L			50	60	12	48.0	0	70	46.6		
C6-GYHERM90-M25L	●	R	GYM25LD-E12-060	●	L			60	75	12	48.0	0	70	46.6		
C6-GYHERM90-M25L	●	R	GYM25LD-E12-075	●	L			75	100	12	48.0	0	70	46.6		
C6-GYHERM90-M25L	●	R	GYM25LD-E12-100	●	L			100	150	12	48.0	0	70	46.6		
C6-GYHERM90-M25L	●	R	GYM25LD-E12-135	●	L			135	200	12	48.0	0	70	46.6		
C6-GYHERM90-M25L	●	R	GYM25LD-E12-180	●	L			180	250	12	48.0	0	70	46.6		
C6-GYHERM90-M25L	●	R	GYM25LD-F12-035	●	L	F	3.0	35	40	12	48.0	0	70	46.6		
C6-GYHERM90-M25L	●	R	GYM25LD-F12-040	●	L			40	50	12	48.0	0	70	46.6		
C6-GYHERM90-M25L	●	R	GYM25LD-F12-050	●	L			50	60	12	48.0	0	70	46.6		
C6-GYHERM90-M25L	●	R	GYM25LD-F12-060	●	L			60	75	12	48.0	0	70	46.6		
C6-GYHERM90-M25L	●	R	GYM25LD-F12-075	●	L			75	100	12	48.0	0	70	46.6		
C6-GYHERM90-M25L	●	R	GYM25LD-F12-100	●	L			100	150	12	48.0	0	70	46.6		
C6-GYHERM90-M25L	●	R	GYM25LD-F12-135	●	L			135	200	12	48.0	0	70	46.6		
C6-GYHERM90-M25L	●	R	GYM25LD-F12-180	●	L			180	250	12	48.0	0	70	46.6		
C6-GYHERM90-M25L	●	R	GYM25LD-F12-225	●	L			225	999	12	48.0	0	70	46.6		
C6-GYHERM90-M25L	●	R	GYM25LD-F20-060	●	L			60	75	20	54.0	0	70	46.6		
C6-GYHERM90-M25L	●	R	GYM25LD-F20-075	●	L			75	100	20	54.0	0	70	46.6		
C6-GYHERM90-M25L	●	R	GYM25LD-F20-100	●	L			100	150	20	54.0	0	70	46.6		
C6-GYHERM90-M25L	●	R	GYM25LD-F20-135	●	L			135	200	20	54.0	0	70	46.6		
C6-GYHERM90-M25L	●	R	GYM25LD-F20-180	●	L			180	250	20	54.0	0	70	46.6		
C6-GYHERM90-M25L	●	R	GYM25LD-F20-225	●	L			225	999	20	54.0	0	70	46.6		
C6-GYHERM90-M25L	●	R	GYM25LD-G14-040	●	L			G	4.0	40	50	14	48.0	0	70	46.6
C6-GYHERM90-M25L	●	R	GYM25LD-G14-050	●	L					50	60	14	48.0	0	70	46.6
C6-GYHERM90-M25L	●	R	GYM25LD-G14-060	●	L	60	85			14	48.0	0	70	46.6		
C6-GYHERM90-M25L	●	R	GYM25LD-G14-085	●	L	85	125			14	48.0	0	70	46.6		
C6-GYHERM90-M25L	●	R	GYM25LD-G14-125	●	L	125	200			14	48.0	0	70	46.6		
C6-GYHERM90-M25L	●	R	GYM25LD-G14-180	●	L	180	280			14	48.0	0	70	46.6		
C6-GYHERM90-M25L	●	R	GYM25LD-G14-250	●	L	250	999			14	48.0	0	70	46.6		
C6-GYHERM90-M25L	●	R	GYM25LD-G25-060	●	L	60	85			25	59.0	0	70	46.6		
C6-GYHERM90-M25L	●	R	GYM25LD-G25-085	●	L	85	125			25	59.0	0	70	46.6		
C6-GYHERM90-M25L	●	R	GYM25LD-G25-125	●	L	125	200			25	59.0	0	70	46.6		
C6-GYHERM90-M25L	●	R	GYM25LD-G25-180	●	L	180	280			25	59.0	0	70	46.6		
C6-GYHERM90-M25L	●	R	GYM25LD-G25-250	●	L	250	999			25	59.0	0	70	46.6		
C6-GYHERM90-M25L	●	R	GYM25LD-H14-050	●	L	H	5.0			50	60	14	48.0	0	70	46.6
C6-GYHERM90-M25L	●	R	GYM25LD-H14-060	●	L					60	85	14	48.0	0	70	46.6
C6-GYHERM90-M25L	●	R	GYM25LD-H14-085	●	L					85	125	14	48.0	0	70	46.6
C6-GYHERM90-M25L	●	R	GYM25LD-H14-125	●	L					125	200	14	48.0	0	70	46.6
C6-GYHERM90-M25L	●	R	GYM25LD-H14-180	●	L					180	280	14	48.0	0	70	46.6
C6-GYHERM90-M25L	●	R	GYM25LD-H14-250	●	L			250	999	14	48.0	0	70	46.6		
C6-GYHERM90-M25L	●	R	GYM25LD-H25-060	●	L			60	85	25	59.0	0	70	46.6		
C6-GYHERM90-M25L	●	R	GYM25LD-H25-085	●	L			85	125	25	59.0	0	70	46.6		
C6-GYHERM90-M25L	●	R	GYM25LD-H25-125	●	L			125	200	25	59.0	0	70	46.6		
C6-GYHERM90-M25L	●	R	GYM25LD-H25-180	●	L			180	280	25	59.0	0	70	46.6		
C6-GYHERM90-M25L	●	R	GYM25LD-H25-250	●	L			250	999	25	59.0	0	70	46.6		

GY GROOVING SERIES

FACE GROOVING

90° TYPE HOLDER

Order number Holder	Stock	Hand	Order number Modular blade	Stock	Hand	Seat size	CW	DAXN	DAXX	CDX	WF	HF	LF	LH
C6-GYHERM90-M25L	●	R	GYM25LD-J14-050	●	L	J	6.0	50	70	14	48.0	0	70	46.6
C6-GYHERM90-M25L	●	R	GYM25LD-J14-070	●	L			70	110	14	48.0	0	70	46.6
C6-GYHERM90-M25L	●	R	GYM25LD-J14-110	●	L			110	200	14	48.0	0	70	46.6
C6-GYHERM90-M25L	●	R	GYM25LD-J14-170	●	L			170	280	14	48.0	0	70	46.6
C6-GYHERM90-M25L	●	R	GYM25LD-J14-250	●	L			250	999	14	48.0	0	70	46.6
C6-GYHERM90-M25L	●	R	GYM25LD-J25-070	●	L			70	110	25	59.0	0	70	46.6
C6-GYHERM90-M25L	●	R	GYM25LD-J25-110	●	L			110	200	25	59.0	0	70	46.6
C6-GYHERM90-M25L	●	R	GYM25LD-J25-170	●	L			170	280	25	59.0	0	70	46.6
C6-GYHERM90-M25L	●	R	GYM25LD-J25-250	●	L			250	999	25	59.0	0	70	46.6
C6-GYHELM90-M25R	●	L	GYM25RD-D12-040	●	R			D	2.0	40	50	12	48.0	0
C6-GYHELM90-M25R	●	L	GYM25RD-D12-050	●	R	50	60			12	48.0	0	70	46.6
C6-GYHELM90-M25R	●	L	GYM25RD-D12-060	●	R	60	75			12	48.0	0	70	46.6
C6-GYHELM90-M25R	●	L	GYM25RD-D12-075	●	R	75	100			12	48.0	0	70	46.6
C6-GYHELM90-M25R	●	L	GYM25RD-D12-100	●	R	100	150			12	48.0	0	70	46.6
C6-GYHELM90-M25R	●	L	GYM25RD-D12-135	●	R	135	200			12	48.0	0	70	46.6
C6-GYHELM90-M25R	●	L	GYM25RD-D12-180	●	R	180	250			12	48.0	0	70	46.6
C6-GYHELM90-M25R	●	L	GYM25RD-E12-040	●	R	40	50			12	48.0	0	70	46.6
C6-GYHELM90-M25R	●	L	GYM25RD-E12-050	●	R	50	60			12	48.0	0	70	46.6
C6-GYHELM90-M25R	●	L	GYM25RD-E12-060	●	R	60	75			12	48.0	0	70	46.6
C6-GYHELM90-M25R	●	L	GYM25RD-E12-075	●	R	E	2.5	75	100	12	48.0	0	70	46.6
C6-GYHELM90-M25R	●	L	GYM25RD-E12-100	●	R			100	150	12	48.0	0	70	46.6
C6-GYHELM90-M25R	●	L	GYM25RD-E12-135	●	R			135	200	12	48.0	0	70	46.6
C6-GYHELM90-M25R	●	L	GYM25RD-E12-180	●	R			180	250	12	48.0	0	70	46.6
C6-GYHELM90-M25R	●	L	GYM25RD-F12-035	●	R			35	40	12	48.0	0	70	46.6
C6-GYHELM90-M25R	●	L	GYM25RD-F12-040	●	R			40	50	12	48.0	0	70	46.6
C6-GYHELM90-M25R	●	L	GYM25RD-F12-050	●	R			50	60	12	48.0	0	70	46.6
C6-GYHELM90-M25R	●	L	GYM25RD-F12-060	●	R			60	75	12	48.0	0	70	46.6
C6-GYHELM90-M25R	●	L	GYM25RD-F12-075	●	R			75	100	12	48.0	0	70	46.6
C6-GYHELM90-M25R	●	L	GYM25RD-F12-100	●	R			100	150	12	48.0	0	70	46.6
C6-GYHELM90-M25R	●	L	GYM25RD-F12-135	●	R	F	3.0	135	200	12	48.0	0	70	46.6
C6-GYHELM90-M25R	●	L	GYM25RD-F12-180	●	R			180	250	12	48.0	0	70	46.6
C6-GYHELM90-M25R	●	L	GYM25RD-F12-225	●	R			225	999	12	48.0	0	70	46.6
C6-GYHELM90-M25R	●	L	GYM25RD-F20-060	●	R			60	75	20	54.0	0	70	46.6
C6-GYHELM90-M25R	●	L	GYM25RD-F20-075	●	R			75	100	20	54.0	0	70	46.6
C6-GYHELM90-M25R	●	L	GYM25RD-F20-100	●	R			100	150	20	54.0	0	70	46.6
C6-GYHELM90-M25R	●	L	GYM25RD-F20-135	●	R			135	200	20	54.0	0	70	46.6
C6-GYHELM90-M25R	●	L	GYM25RD-F20-180	●	R			180	250	20	54.0	0	70	46.6
C6-GYHELM90-M25R	●	L	GYM25RD-F20-225	●	R			225	999	20	54.0	0	70	46.6

Order number Holder	Stock	Hand	Order number Modular blade	Stock	Hand	Seat size	CW	DAXN	DAXX	CDX	WF	HF	LF	LH		
C6-GYHELM90-M25R	●	L	GYM25RD-G14-040	●	R	G	4.0	40	50	14	48.0	0	70	46.6		
C6-GYHELM90-M25R	●	L	GYM25RD-G14-050	●	R			50	60	14	48.0	0	70	46.6		
C6-GYHELM90-M25R	●	L	GYM25RD-G14-060	●	R			60	85	14	48.0	0	70	46.6		
C6-GYHELM90-M25R	●	L	GYM25RD-G14-085	●	R			85	125	14	48.0	0	70	46.6		
C6-GYHELM90-M25R	●	L	GYM25RD-G14-125	●	R			125	200	14	48.0	0	70	46.6		
C6-GYHELM90-M25R	●	L	GYM25RD-G14-180	●	R			180	280	14	48.0	0	70	46.6		
C6-GYHELM90-M25R	●	L	GYM25RD-G14-250	●	R			250	999	14	48.0	0	70	46.6		
C6-GYHELM90-M25R	●	L	GYM25RD-G25-060	●	R			60	85	25	59.0	0	70	46.6		
C6-GYHELM90-M25R	●	L	GYM25RD-G25-085	●	R			85	125	25	59.0	0	70	46.6		
C6-GYHELM90-M25R	●	L	GYM25RD-G25-125	●	R			125	200	25	59.0	0	70	46.6		
C6-GYHELM90-M25R	●	L	GYM25RD-G25-180	●	R			180	280	25	59.0	0	70	46.6		
C6-GYHELM90-M25R	●	L	GYM25RD-G25-250	●	R			250	999	25	59.0	0	70	46.6		
C6-GYHELM90-M25R	●	L	GYM25RD-H14-050	●	R			H	5.0	50	60	14	48.0	0	70	46.6
C6-GYHELM90-M25R	●	L	GYM25RD-H14-060	●	R					60	85	14	48.0	0	70	46.6
C6-GYHELM90-M25R	●	L	GYM25RD-H14-085	●	R	85	125			14	48.0	0	70	46.6		
C6-GYHELM90-M25R	●	L	GYM25RD-H14-125	●	R	125	200			14	48.0	0	70	46.6		
C6-GYHELM90-M25R	●	L	GYM25RD-H14-180	●	R	180	280			14	48.0	0	70	46.6		
C6-GYHELM90-M25R	●	L	GYM25RD-H14-250	●	R	250	999			14	48.0	0	70	46.6		
C6-GYHELM90-M25R	●	L	GYM25RD-H25-060	●	R	60	85			25	59.0	0	70	46.6		
C6-GYHELM90-M25R	●	L	GYM25RD-H25-085	●	R	85	125			25	59.0	0	70	46.6		
C6-GYHELM90-M25R	●	L	GYM25RD-H25-125	●	R	125	200			25	59.0	0	70	46.6		
C6-GYHELM90-M25R	●	L	GYM25RD-H25-180	●	R	180	280			25	59.0	0	70	46.6		
C6-GYHELM90-M25R	●	L	GYM25RD-H25-250	●	R	250	999			25	59.0	0	70	46.6		
C6-GYHELM90-M25R	●	L	GYM25RD-J14-050	●	R	J	6.0			50	70	14	48.0	0	70	46.6
C6-GYHELM90-M25R	●	L	GYM25RD-J14-070	●	R					70	110	14	48.0	0	70	46.6
C6-GYHELM90-M25R	●	L	GYM25RD-J14-110	●	R					110	200	14	48.0	0	70	46.6
C6-GYHELM90-M25R	●	L	GYM25RD-J14-170	●	R			170	280	14	48.0	0	70	46.6		
C6-GYHELM90-M25R	●	L	GYM25RD-J14-250	●	R			250	999	14	48.0	0	70	46.6		
C6-GYHELM90-M25R	●	L	GYM25RD-J25-070	●	R			70	110	25	59.0	0	70	46.6		
C6-GYHELM90-M25R	●	L	GYM25RD-J25-110	●	R			110	200	25	59.0	0	70	46.6		
C6-GYHELM90-M25R	●	L	GYM25RD-J25-170	●	R			170	280	25	59.0	0	70	46.6		
C6-GYHELM90-M25R	●	L	GYM25RD-J25-250	●	R			250	999	25	59.0	0	70	46.6		

1. The indicated dimensions are values for standard inserts (GM breakers). If other inserts are mounted, LF and LH may differ. Select the inserts and recommended conditions from "Brochure B140".

GY GROOVING SERIES

EXTERNAL RECESSING

50° TYPE HOLDER

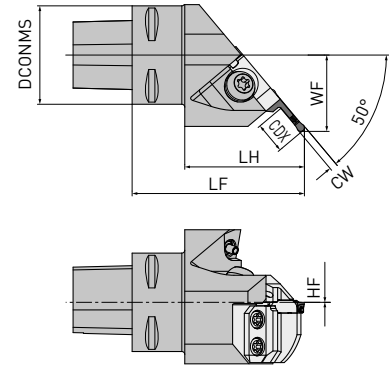

Left hand tool holder shown.

- Please order the modular blade and modular holder separately.
- Please set a left hand modular blade on a right hand holder and a right hand modular blade on a left hand holder.

Order number	Stock	Hand		Mounting size	DCONMS	CW
C4-GYHERM50-M25L	●	R	✓	PSC40	40	2.0-6.35
C4-GYHELM50-M25R	●	L	✓	PSC40	40	2.0-6.35
C5-GYHERM50-M25L	●	R	✓	PSC50	50	2.0-6.35
C5-GYHELM50-M25R	●	L	✓	PSC50	50	2.0-6.35
C6-GYHERM50-M25L	●	R	✓	PSC63	60	2.0-6.35
C6-GYHELM50-M25R	●	L	✓	PSC63	60	2.0-6.35

SET DIMENSIONS WITH MODULAR BLADES

Order number Holder	Stock	Hand	Order number Modular blade	Stock	Hand	Seat size	CW	CDX	DMIN	APMX	APMX2	WF	HF	LF	LH
C4-GYHERM50-M25L	●	R	GYM25LC-D005	●	L	D	2.0	0.5	30	1.5	0.646	30.6	0	70.2	48.8
C4-GYHERM50-M25L	●	R	GYM25LC-E005	●	L	E	2.5	0.5	30	1.75	0.720	30.8	0	70.1	48.7
C4-GYHERM50-M25L	●	R	GYM25LC-F005	●	L	F	3.0	0.5	30	2	0.793	31.0	0	70.0	48.6
C4-GYHERM50-M25L	●	R	GYM25LC-G005	●	L	G	4.0	0.5	30	2.5	0.939	31.4	0	69.8	48.4
C4-GYHERM50-M25L	●	R	GYM25LC-H005	●	L	H	5.0	0.5	30	2.88	1.049	31.8	0	69.6	48.2
C4-GYHERM50-M25L	●	R	GYM25LC-J005	●	L	J	6.0	0.5	30	3.5	1.232	32.4	0	69.4	48.0
C4-GYHELM50-M25R	●	L	GYM25RC-D005	●	R	D	2.0	0.5	30	1.5	0.646	30.6	0	70.2	48.8
C4-GYHELM50-M25R	●	L	GYM25RC-E005	●	R	E	2.5	0.5	30	1.75	0.720	30.8	0	70.1	48.7
C4-GYHELM50-M25R	●	L	GYM25RC-F005	●	R	F	3.0	0.5	30	2	0.793	31.0	0	70.0	48.6
C4-GYHELM50-M25R	●	L	GYM25RC-G005	●	R	G	4.0	0.5	30	2.5	0.939	31.4	0	69.8	48.4
C4-GYHELM50-M25R	●	L	GYM25RC-H005	●	R	H	5.0	0.5	30	2.88	1.049	31.8	0	69.6	48.2
C4-GYHELM50-M25R	●	L	GYM25RC-J005	●	R	J	6.0	0.5	30	3.5	1.232	32.4	0	69.4	48.0
C5-GYHERM50-M25L	●	R	GYM25LC-D005	●	L	D	2.0	0.5	30	1.5	0.646	32.6	0	70.2	48.8
C5-GYHERM50-M25L	●	R	GYM25LC-E005	●	L	E	2.5	0.5	30	1.75	0.720	32.8	0	70.1	48.7
C5-GYHERM50-M25L	●	R	GYM25LC-F005	●	L	F	3.0	0.5	30	2	0.793	33.0	0	70.0	48.6
C5-GYHERM50-M25L	●	R	GYM25LC-G005	●	L	G	4.0	0.5	30	2.5	0.939	33.4	0	69.8	48.4
C5-GYHERM50-M25L	●	R	GYM25LC-H005	●	L	H	5.0	0.5	30	2.88	1.049	33.8	0	69.6	48.2

Order number Holder	Stock	Hand	Order number Modular blade	Stock	Hand	Seat size	CW	CDX	DMIN	APMX	APMX2	WF	HF	LF	LH
C5-GYHERM50-M25L	●	R	GYM25LC-J005	●	L	J	6.0	0.5	30	3.5	1.232	34.4	0	69.4	48.0
C5-GYHELM50-M25R	●	L	GYM25RC-D005	●	R	D	2.0	0.5	30	1.5	0.646	32.6	0	70.2	48.8
C5-GYHELM50-M25R	●	L	GYM25RC-E005	●	R	E	2.5	0.5	30	1.75	0.720	32.8	0	70.1	48.7
C5-GYHELM50-M25R	●	L	GYM25RC-F005	●	R	F	3.0	0.5	30	2	0.793	33.0	0	70.0	48.6
C5-GYHELM50-M25R	●	L	GYM25RC-G005	●	R	G	4.0	0.5	30	2.5	0.939	33.4	0	69.8	48.4
C5-GYHELM50-M25R	●	L	GYM25RC-H005	●	R	H	5.0	0.5	30	2.88	1.049	33.8	0	69.6	48.2
C5-GYHELM50-M25R	●	L	GYM25RC-J005	●	R	J	6.0	0.5	30	3.5	1.232	34.4	0	69.4	48.0
C6-GYHERM50-M25L	●	R	GYM25LC-D005	●	L	D	2.0	0.5	30	1.5	0.646	39.6	0	70.2	46.8
C6-GYHERM50-M25L	●	R	GYM25LC-E005	●	L	E	2.5	0.5	30	1.75	0.720	39.8	0	70.1	46.7
C6-GYHERM50-M25L	●	R	GYM25LC-F005	●	L	F	3.0	0.5	30	2	0.793	40.0	0	70.0	46.6
C6-GYHERM50-M25L	●	R	GYM25LC-G005	●	L	G	4.0	0.5	30	2.5	0.939	40.4	0	69.8	46.4
C6-GYHERM50-M25L	●	R	GYM25LC-H005	●	L	H	5.0	0.5	30	2.88	1.049	40.8	0	69.6	46.2
C6-GYHERM50-M25L	●	R	GYM25LC-J005	●	L	J	6.0	0.5	30	3.5	1.232	41.4	0	69.4	46.0
C6-GYHELM50-M25R	●	L	GYM25RC-D005	●	R	D	2.0	0.5	30	1.5	0.646	39.6	0	70.2	46.8
C6-GYHELM50-M25R	●	L	GYM25RC-E005	●	R	E	2.5	0.5	30	1.75	0.720	39.8	0	70.1	46.7
C6-GYHELM50-M25R	●	L	GYM25RC-F005	●	R	F	3.0	0.5	30	2	0.793	40.0	0	70.0	46.6
C6-GYHELM50-M25R	●	L	GYM25RC-G005	●	R	G	4.0	0.5	30	2.5	0.939	40.4	0	69.8	46.4
C6-GYHELM50-M25R	●	L	GYM25RC-H005	●	R	H	5.0	0.5	30	2.88	1.049	40.8	0	69.6	46.2
C6-GYHELM50-M25R	●	L	GYM25RC-J005	●	R	J	6.0	0.5	30	3.5	1.232	41.4	0	69.4	46.0

1. The indicated dimensions are values for standard inserts (BM breakers). If other inserts are mounted, LF and LH may differ.
 Select the inserts and recommended conditions from "Brochure B140".

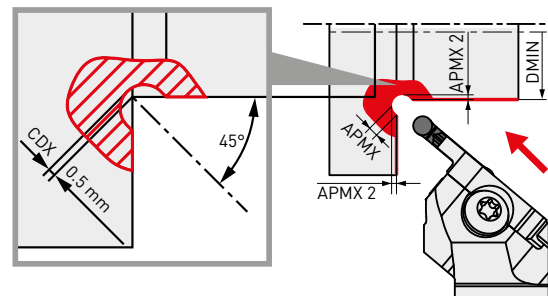

Enlarged view

GY GROOVING SERIES

SPARE PARTS FOR PSC HOLDER



4 pcs



Clamp screw

Blade screw

Plug

Nozzle

Wrench 1

Wrench 2

GY06013M

TS55

HSD05004S

NZ22042080S

TKY25D

TKY30R

* Clamp Torque (N • m): GY06013M = 6.0, TS55 = 5.0

Nozzle Exchange Key: NZKH050S

IDENTIFICATION

MODULAR BLADE

External Recessing

	GY	M25	R	A	-	F	12	
Series description	Modular blade size	Hand		Modular blade type			Seat size*1	Max. groove depth*2
	M25	R Right L Left		A Standard type C External recessing D Face grooving			D 2.00 mm 2.24 mm 2.39 mm E 2.50 mm 2.74 mm 3.00 mm F 3.18 mm 3.24 mm G 4.00 mm 4.24 mm 4.75 mm H 5.00 mm 5.24 mm 6.00 mm J 6.31 mm 6.35 mm	005 0.5 mm 06 6 mm : 25 25 mm

Face grooving

GY	M25	R	D	-	F	12	050	
								Min. groove diameter
								035 35 mm 040 40 mm : 250 250 mm

Note: Dimension symbols conforming to ISO13399.

*1 Select a seat size with the same symbol as that of the insert.

*2 The maximum groove depth is a value when used for external grooving and changes according to the insert used.

GY GROOVING SERIES

RECOMMENDED CUTTING CONDITIONS

CUTTING SPEED (FOR EXTERNAL GROOVING)

Material	Hardness	Grade	Vc	
P	Mild steels	VP20RT	155 (100-220)	
		VP10RT	170 (110-230)	
		NX2525	150 (90-210)	
	Carbon steels Alloy steels	160-280HB	VP20RT	120 (80-180)
			VP10RT	140 (90-190)
			MY5015	180 (110-250)
			NX2525	120 (70-170)
		≥280HB	VP20RT	100 (60-140)
			VP10RT	110 (70-150)
			MY5015	150 (90-210)
M	Stainless steel	VP20RT	100 (60-140)	
		VP10RT	110 (70-150)	
K	Gray cast iron	VP20RT	120 (80-180)	
		VP10RT	140 (90-190)	
		MY5015	120 (140-300)	
	Ductile cast iron	VP20RT	100 (60-140)	
		VP10RT	110 (70-150)	
N	Aluminium alloy (A6061, 7075)	VP20RT	150 (90-210)	
		VP10RT	110 (70-150)	
		MY5015	150 (90-210)	
N	Aluminium alloy (AC4B)	VP20RT	120 (80-180)	
		VP10RT	140 (90-190)	
		MY5015	120 (140-300)	
N	Aluminium alloy (ADC12, A390)	VP20RT	100 (60-140)	
		VP10RT	110 (70-150)	
		MY5015	150 (90-210)	
S	Heat resistant alloy Titanium alloy	MP9015	70 (40-100)	
		MP9025	60 (30- 90)	
		VP20RT	45 (30- 60)	
		VP10RT	55 (40- 70)	
		RT9010	55 (40- 70)	
H	Hardened steel	≥50HRC	BC8110	90 (60-120)
			MB8025	90 (60-120)

1. **VP20RT** is the first recommended grade for materials other than hardened steel.
2. For VP10RT, VP20RT, MP9015, MP9025 and MY5015, wet cutting is recommended.
3. GL Chipbreaker is not recommended for face grooving.

RECOMMENDED FEED RATE

RECOMMENDED CUTTING CONDITIONS (FOR EXTERNAL GROOVING)

Below are the recommended cutting conditions when using the modular holder GYHR/L2525M00/90-M25R/L with the modular blade GYM25R/LA-○○○.

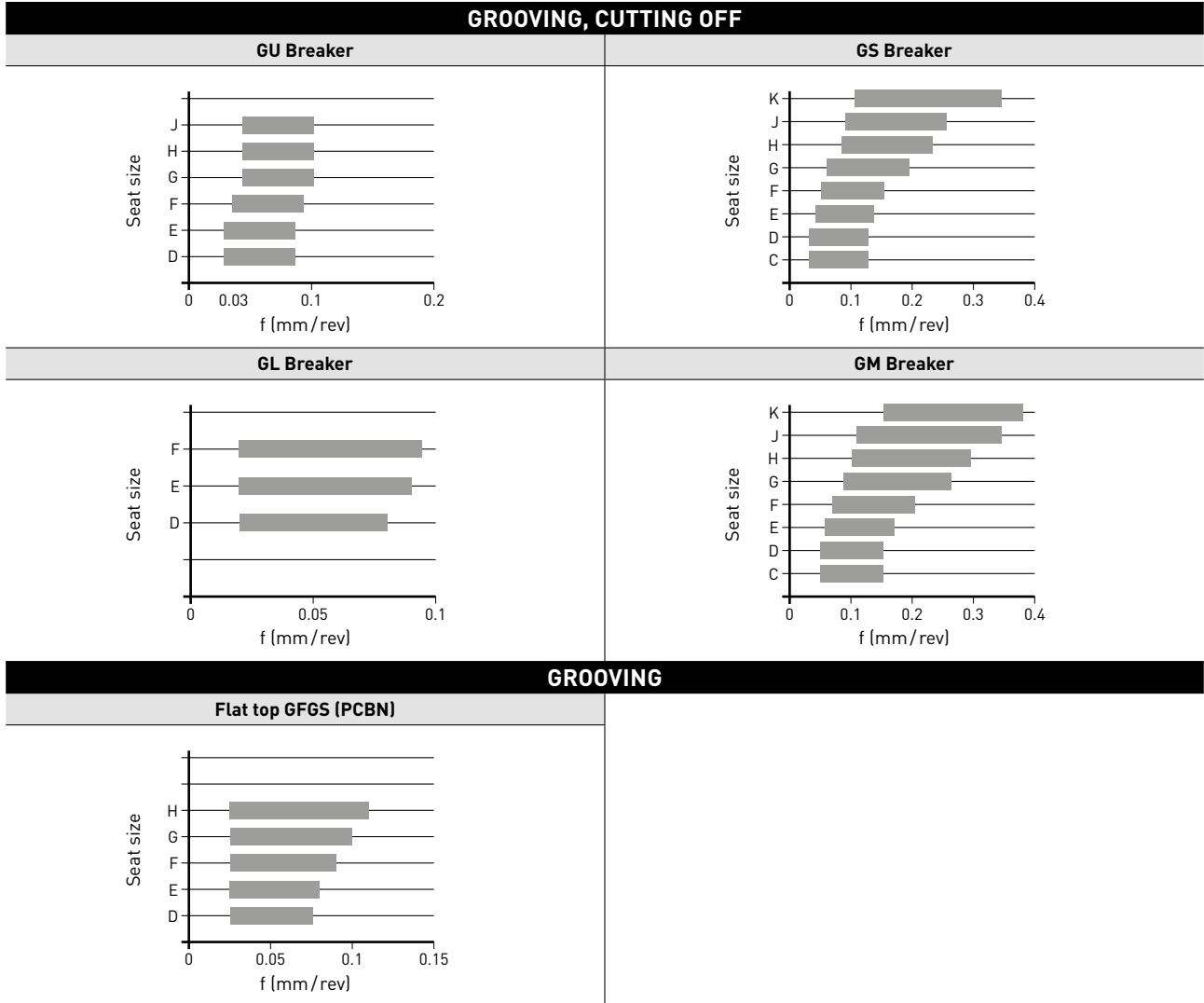

RECOMMENDED FEED RATE AND DEPTH OF CUT

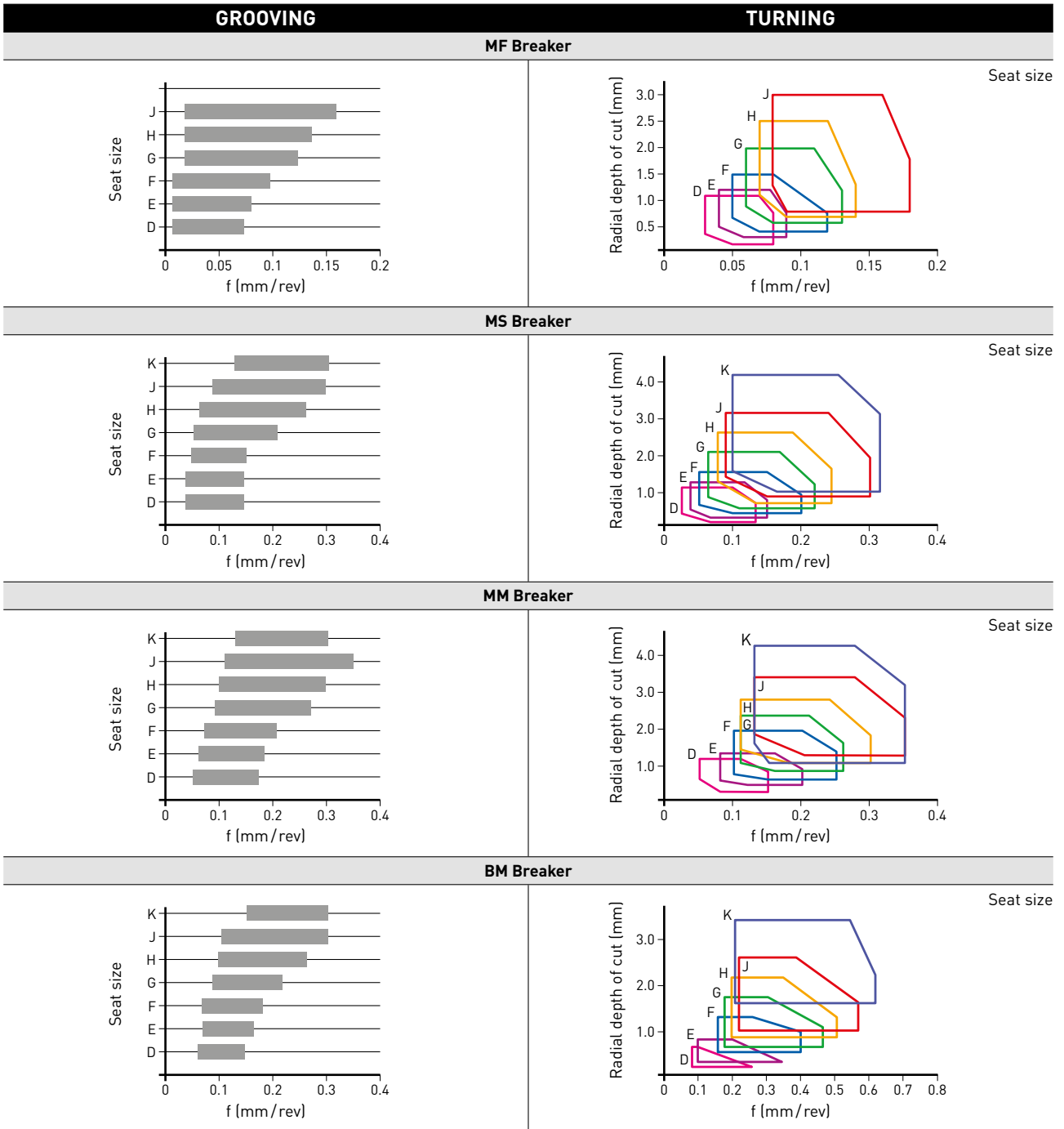

Seat size	C	D	E	F	G	H	J	K
	1.50	2.00	2.39	3.00	4.00	4.75	6.00	8.00
Insert width (mm)	-	2.24	2.50	3.18	4.24	5.00	6.31	-
	-	-	2.74	3.24	-	5.24	6.35	-

RECOMMENDED DEPTH OF CUT

LIMITATION OF THE MAXIMUM GROOVE DEPTH (FOR EXTERNAL GROOVING)

- When using the modular blade GYM○○○R/LA-○○○
- The maximum groove depth is not limited by the workpiece diameter.
- When using the modular blade GYM○○○R/LB-○○○
- The maximum groove depth is limited by the workpiece diameter.

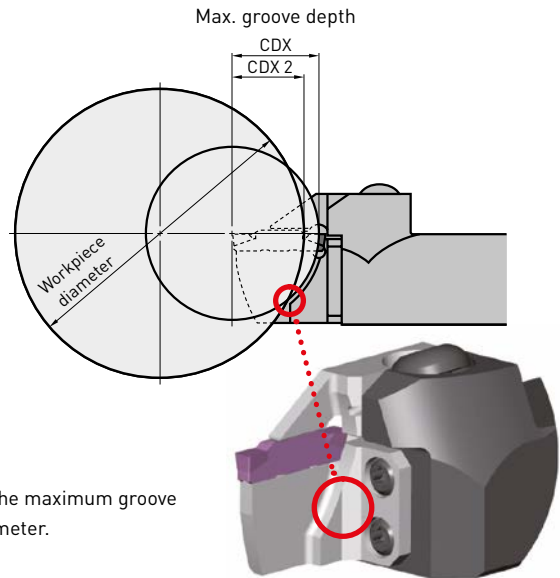
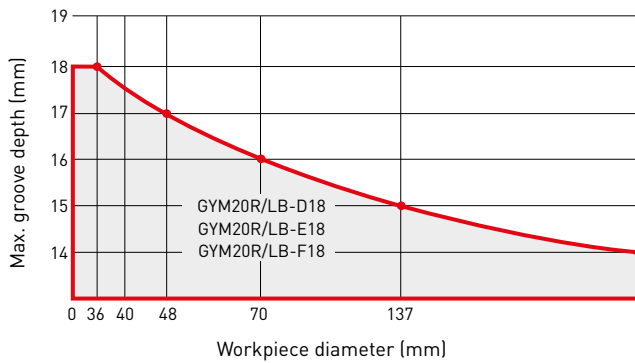

Due to the interference on this part, the maximum groove depth is limited by the workpiece diameter.

RECOMMENDED CUTTING CONDITIONS

RECOMMENDED CUTTING SPEED (M/MIN) (FOR EXTERNAL RECESSING)

Material	Hardness	Grade	Vc
P Mild steels Carbon steels Alloy steels	<180HB	VP20RT	80-180
		VP10RT	90-190
	180-280HB	VP20RT	60-140
		VP10RT	70-150
		MY5015	90-210
		NX2525	55-135
		VP20RT	50-110
		VP10RT	60-120
	280-350HB	MY5015	80-160
		NX2525	45-105
VP20RT		50-110	
M Stainless steel	≤350HB	VP10RT	60-120
		VP20RT	60-140
K Gray cast iron Ductile cast iron	Tensile strength ≤350MPa	VP10RT	70-150
		MY5015	90-210
		VP20RT	50-110
	Tensile strength ≤800MPa	VP10RT	60-120
		MY5015	80-160
S Titanium alloy Heat resistant alloy	-	MP9015	40-100
		MP9025	30- 90
		VP20RT	30- 60
		VP10RT	40- 70
		VP20RT	30- 60
		VP10RT	40- 70

1. VP20RT is the first recommended grade for materials other than hardened steel.
2. For VP10RT, VP20RT, MP9015, MP9025 and MY5015, wet cutting is recommended.

RECOMMENDED FEED RATE AND DEPTH OF CUT

DISTANCE FROM THE WORKPIECE TO THE RECESS DEPTH

Grooving width CW	Recessing depth APMX	Distance workpiece to the recess depth APMX 2
2.00	1.50	0.646
2.50	1.75	0.720
3.00	2.00	0.793
3.18	2.09	0.819
4.00	2.50	0.939
4.75	2.88	1.049
5.00	3.00	1.086
6.00	3.50	1.232
6.35	3.68	1.283

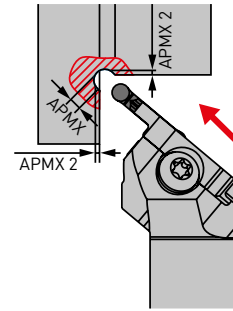

BM BREAKER

MINIMUM GROOVING DIAMETER

Ensure the tool is suitable for the diameter being machined. Refer to the Min. Grooving Diameter DMIN as shown in the table on page 37 to avoid a collision with the workpiece as shown below.

Recommended feed rate and depth of cut

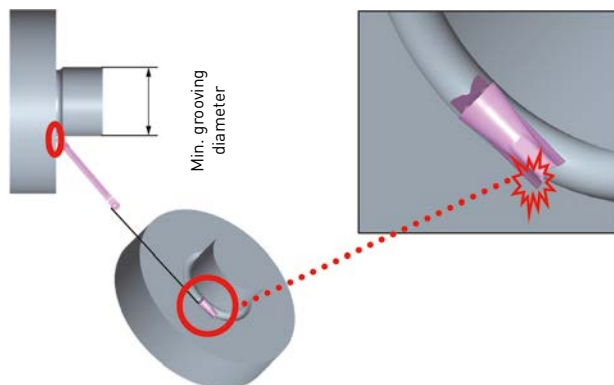
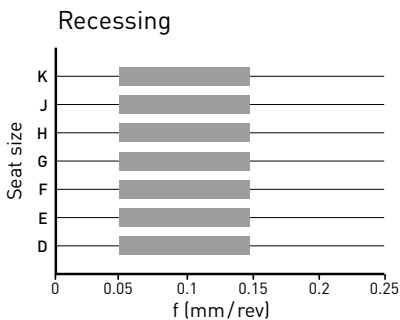

RECOMMENDED CUTTING CONDITIONS

RECOMMENDED CUTTING SPEED (M / MIN) (FOR FACE GROOVING)

Material	Hardness	Grade	Vc
P Mild steels Carbon steels Alloy steels	<160HB	VP20RT	130 (80-180)
		VP10RT	140 (90-190)
		NX2525	120 (70-170)
	160-280HB	VP20RT	100 (60-140)
		VP10RT	110 (70-150)
		MY5015	150 (90-210)
		NX2525	95 (55-135)
		VP20RT	80 (50-110)
		VP10RT	90 (60-120)
≥280HB	MY5015	120 (80-160)	
	NX2525	75 (45-105)	
	VP20RT	80 (50-110)	
M Stainless steel	≤270HB	VP10RT	90 (60-120)
		VP20RT	100 (60-140)
K Gray cast iron Ductile cast iron	Tensile strength ≤300MPa	VP20RT	110 (70-150)
		VP10RT	150 (90-210)
		MY5015	80 (50-110)
	Tensile strength ≤800MPa	VP20RT	90 (60-120)
		VP10RT	120 (80-160)
		MY5015	70 (40-100)
S Heat resistant alloy Titanium alloy	—	MP9015	60 (30- 90)
		MP9025	45 (30- 60)
		VP20RT	55 (40- 70)
		VP10RT	55 (40- 70)
		RT9010	80 (60-100)
H Hardened steel	≥50HRC	BC8110	80 (60-100)
		MB8025	80 (60-100)

1. VP20RT is the first recommended grade for materials other than hardened steel.
2. For VP10RT, VP20RT, MP9015, MP9025 and MY5015, wet cutting is recommended.

RELATIONSHIP BETWEEN THE MODULAR BLADE AND FEED PER ROTATION (FOR FACE GROOVING)

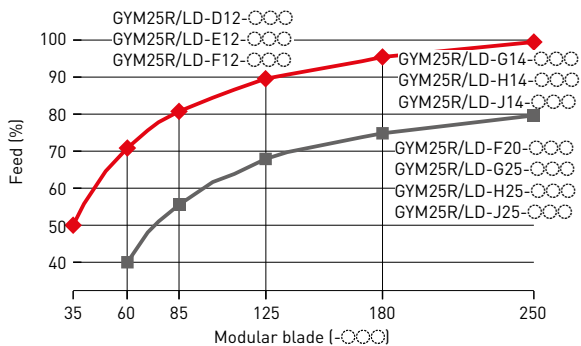

1. Adjust the feed per rotation in the cutting conditions to the percentage shown in the table above.

RECOMMENDED CUTTING CONDITIONS (FOR FACE GROOVING)

FACE GROOVING

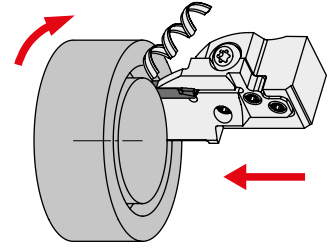
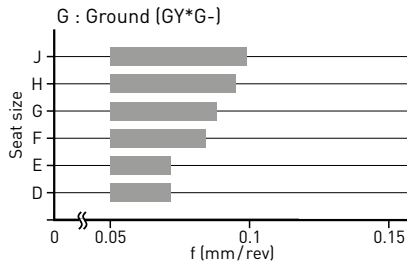
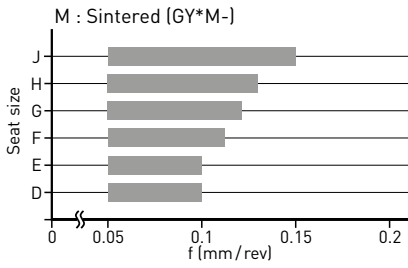

FACE PLUNGING

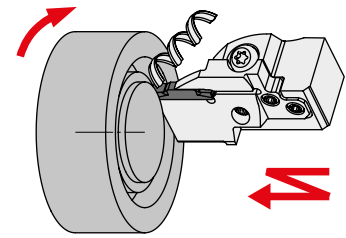
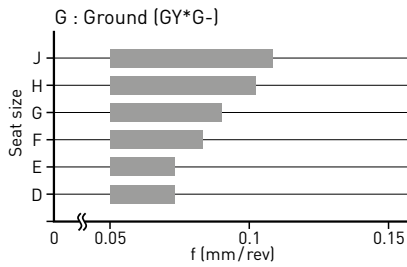
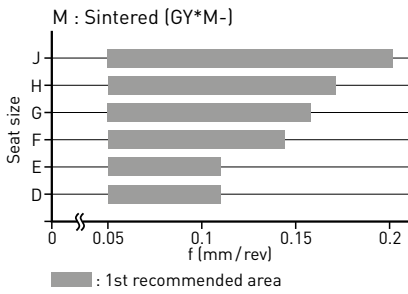

* After the 1st plunge, the width of cut should be set narrower than insert width CW.

TRAVERSE MACHINING (MF BREAKER)

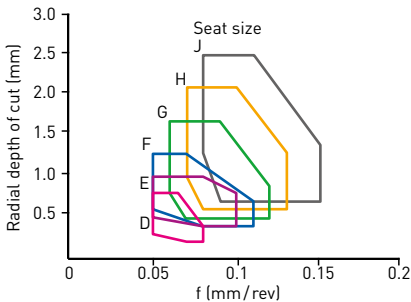

Seat size		Seat size	
Insert width (mm)		Insert width (mm)	
D	2.00	G	4.00
	2.24		4.24
E	2.39	H	5.00
	2.50		5.24
	2.74		5.24
F	3.00	J	6.00
	3.18		6.31
	3.24		6.35

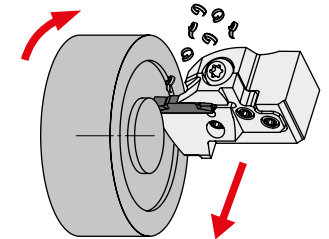

TRAVERSE MACHINING (MM/MS BREAKER)

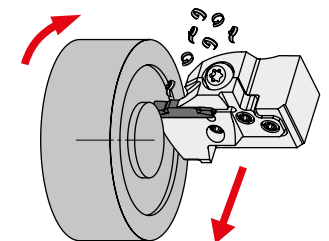
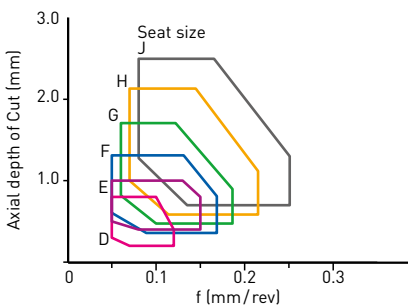

TRAVERSE MACHINING (BM BREAKER)

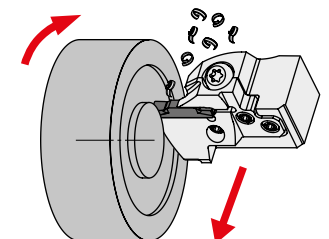
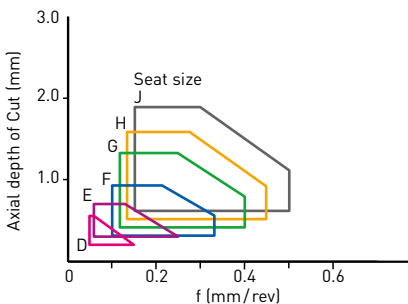

GERMANY

MMC HARTMETALL GMBH
Comeniusstr. 2 . 40670 Meerbusch
Phone +49 2159 91890 . Fax +49 2159 918966
Email admin@mmchg.de

U.K.

MMC HARDMETAL U.K. LTD.
Mitsubishi House . Galena Close . Tamworth . Staffs. B77 4AS
Phone +44 1827 312312
Email sales@mitsubishicarbide.co.uk

SPAIN

MITSUBISHI MATERIALS ESPAÑA, S.A.
Calle Emperador 2 . 46136 Museros/Valencia
Phone +34 96 1441711 . Fax +34 96 1443786
Email comercial@mmevalencia.es

FRANCE

MMC METAL FRANCE S.A.R.L.
6, Rue Jacques Monod . 91400 Orsay
Phone +33 1 69 35 53 53 . Fax +33 1 69 35 53 50
Email mmfsales@mmc-metal-france.fr

POLAND

MMC HARDMETAL POLAND SP. Z O.O
Al. Armii Krajowej 61 . 50-541 Wrocław
Phone +48 71335 1620 . Fax +48 71335 1621
Email sales@mitsubishicarbide.com.pl

ITALY

MMC ITALIA S.R.L.
Viale Certosa 144 . 20156 Milano
Phone +39 0293 77031 . Fax +39 0293 589093
Email info@mmc-italia.it

TURKEY

MMC HARTMETALL GMBH ALMANYA - İZMİR MERKEZ ŞUBESİ
Adalet Mahallesi Anadolu Caddesi No: 41-1 . 15001 35530 Bayraklı/İzmir
Phone +90 232 5015000 . Fax +90 232 5015007
Email info@mmchg.com.tr

www.mmc-carbide.com

DISTRIBUTED BY:

□

□

└

└